

2019中国国际进口博览会

2019 China International Import Expo

食品及农产品展区

Food & Agricultural Products

8. 2H

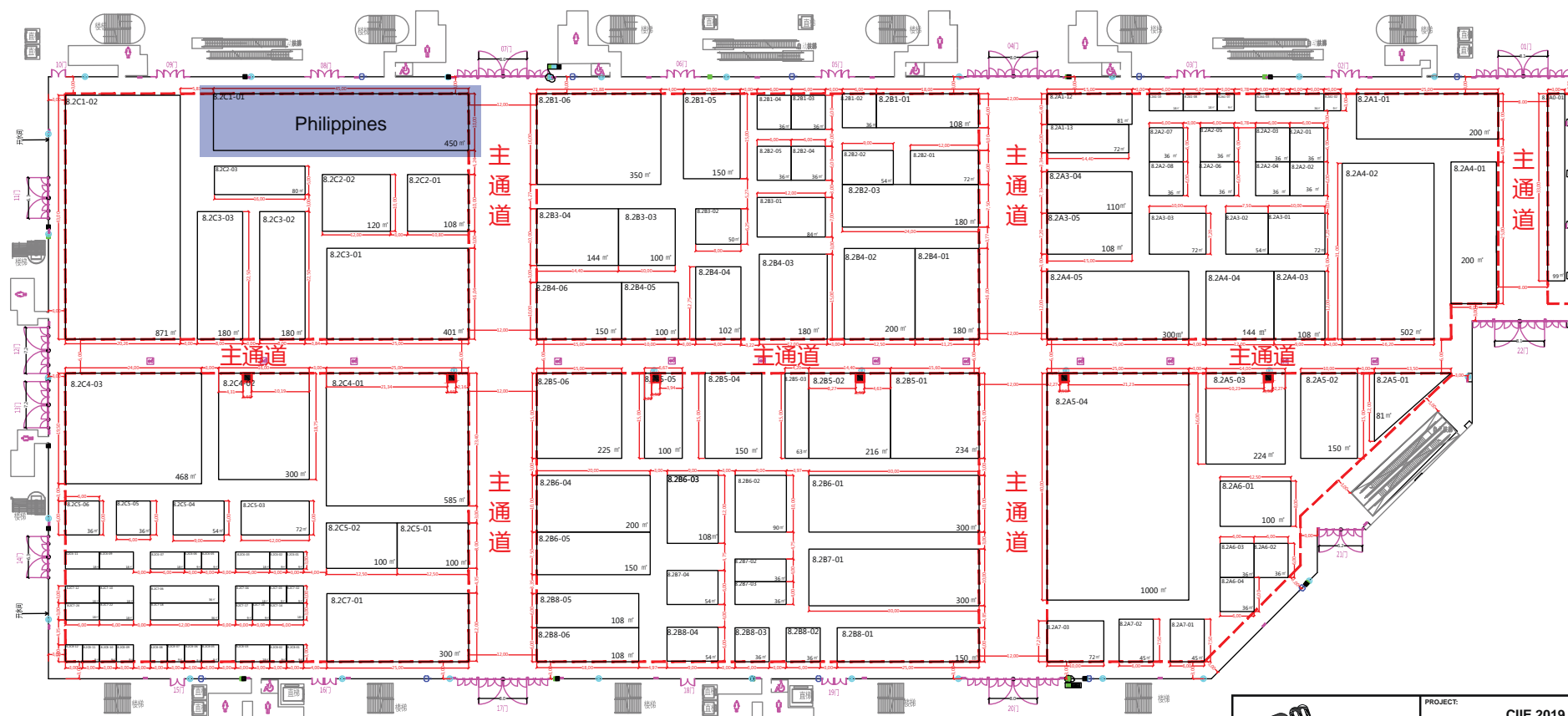
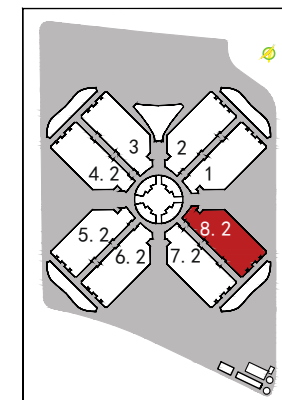

 EXHIBITION AND DESIGN DIVISION	PROJECT:	CII E 2019	CONTENT:	DETAILS	
	TITLE:	COMMODITY PAVILION	DESIGNER:	MIR	
DATE:	10/10/2019	REVISION:	01	LOCATION:	SHANGHAI, CHINA
			SHEET NO.:	1	

**PERSPECTIVE
COMMODITY PAVILION**



	PROJECT:	CIE 2019	CONTENT:	DETAILS	
	TITLE:	COMMODITY PAVILION	DESIGNER:	MIR	
DATE:	10/10/2019	REVISION:	01	LOCATION:	SHANGHAI, CHINA
				SHEET NO.:	2

FLOOR PLAN

COMMODITY PAVILION

NOTE: PAVILION OVERHEAD ARE NOT SHOWN FOR CLARITY

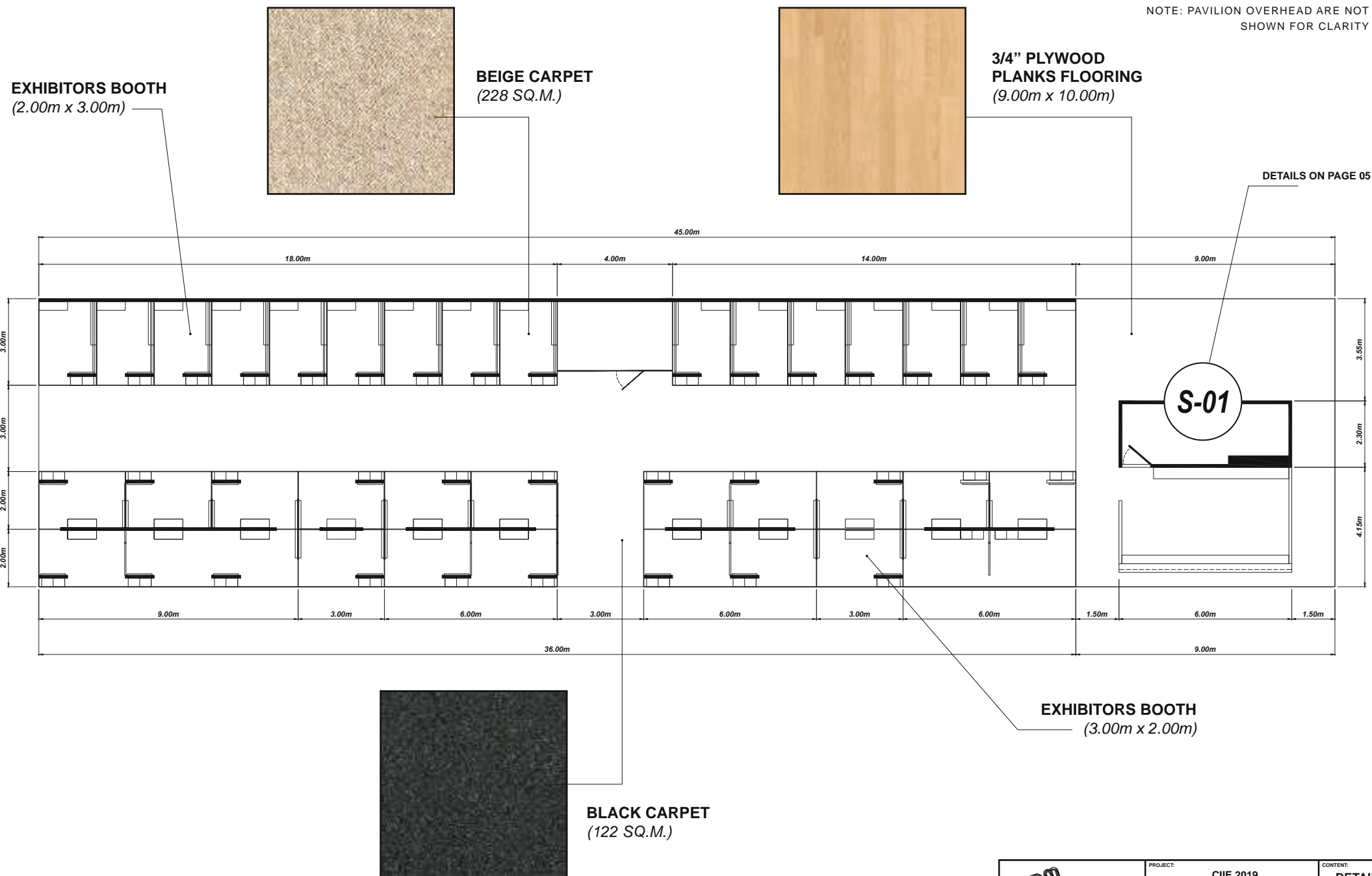

	PROJECT:	CIE 2019	CONTENT:	DETAILS	
	TITLE:	COMMODITY PAVILION	DESIGNER:	MIR	
DATE:	10/10/2019	REVISION:	01	LOCATION:	SHANGHAI, CHINA
			SHEET NO.:	3	

DETAIL

COMMODITY OVERHEAD - 01

NOTE: SHELVESTABLE, CHAIRS AND LOUNGE AREA ARE NOT SHOWN FOR CLARITY

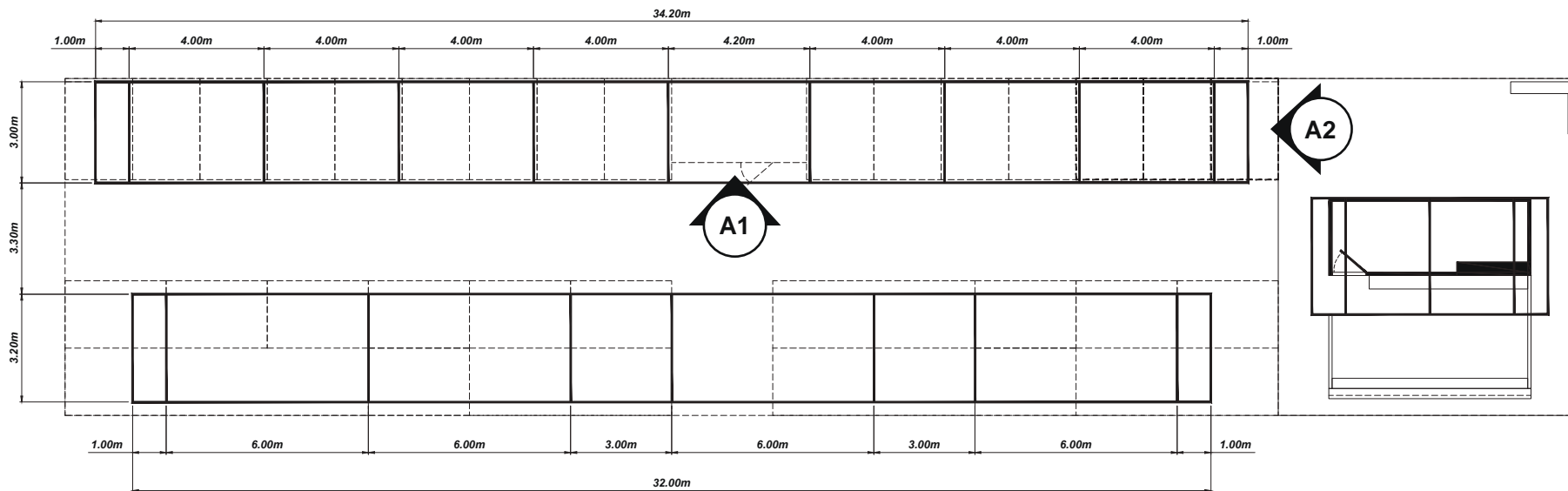

TYPICAL FINISH FOR ALL METAL BARS
2" X 2" 1.5MM THK SQUARE HOLLOW METAL IN PANTONE 7543 U

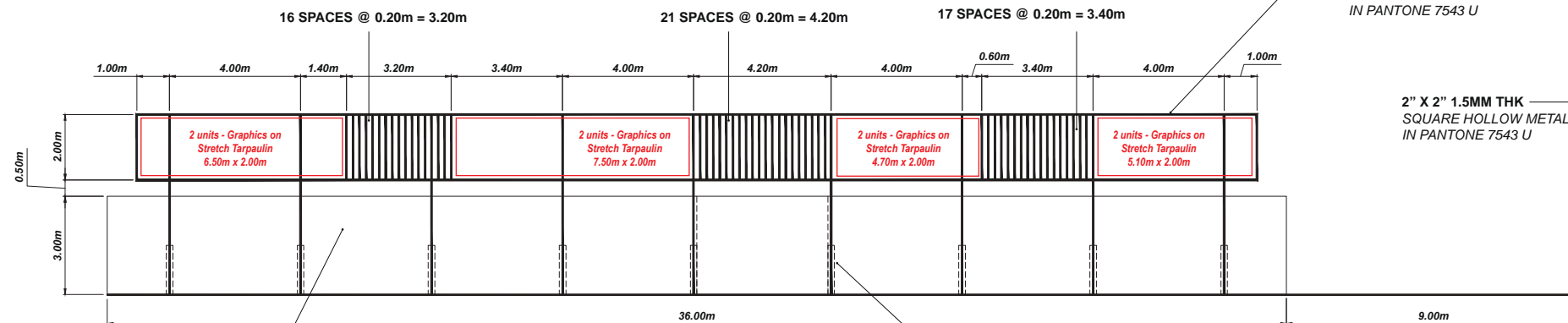

ELEVATION A1



WOODEN WALL IN 3/4 PLYWOOD IN PANTONE 2455 U



WOODEN PARTITION 3/4 PLYWOOD IN PANTONE 9241 U

2" X 2" 1.5MM THK SQUARE HOLLOW METAL IN PANTONE 7543 U

2" X 2" 1.5MM THK SQUARE HOLLOW METAL IN PANTONE 7543 U

WOODEN PARTITION 3/4 PLYWOOD IN PANTONE 9241 U

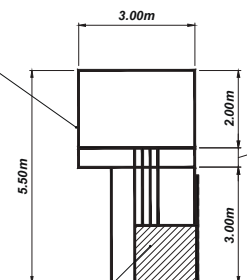

ELEVATION A2

<p>EXHIBITION AND DESIGN DIVISION</p>	PROJECT:	CIIE 2019	CONTENT:	DETAILS	
	TITLE:	COMMODITY PAVILION	DESIGNER:	MIR	
DATE:	10/10/2019	REVISION:	01	LOCATION:	SHANGHAI, CHINA
				SHEET NO.:	4

DETAILS

COMMODITY OVERHEAD - 02

NOTE: TABLE, CHAIRS AND LOUNGE AREA ARE NOT SHOWN FOR CLARITY

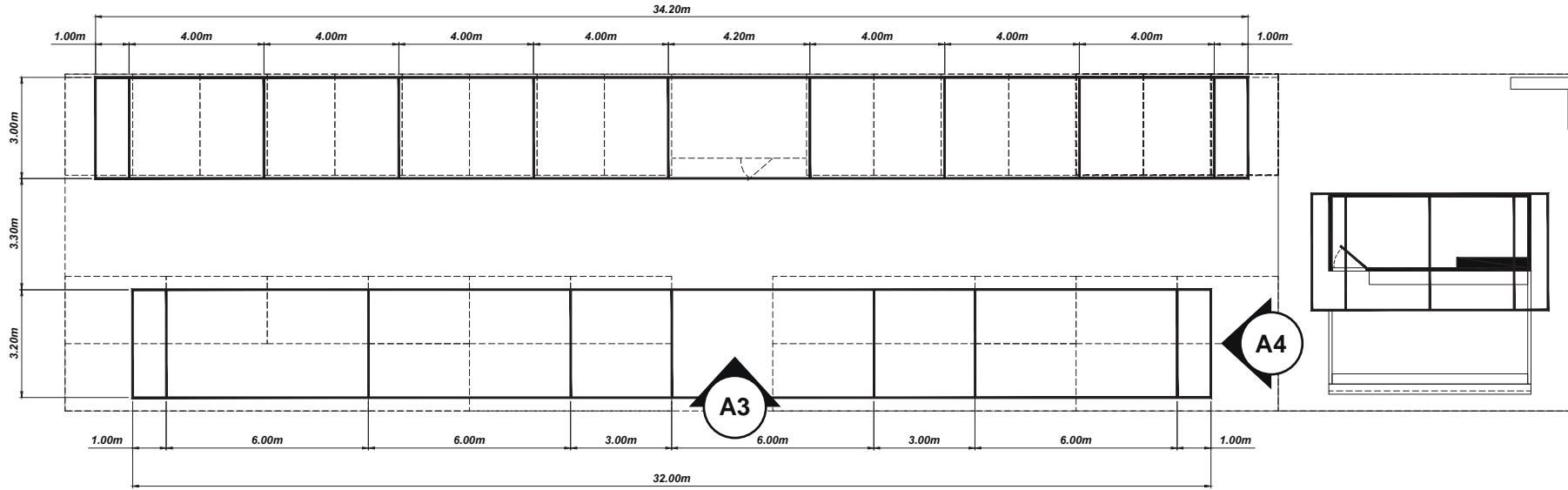

TYPICAL FINISH FOR ALL METAL BARS
2" X 2" 1.5MM THK SQUARE HOLLOW METAL IN PANTONE 7543 U

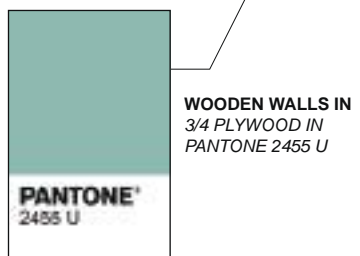
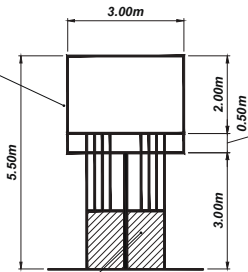
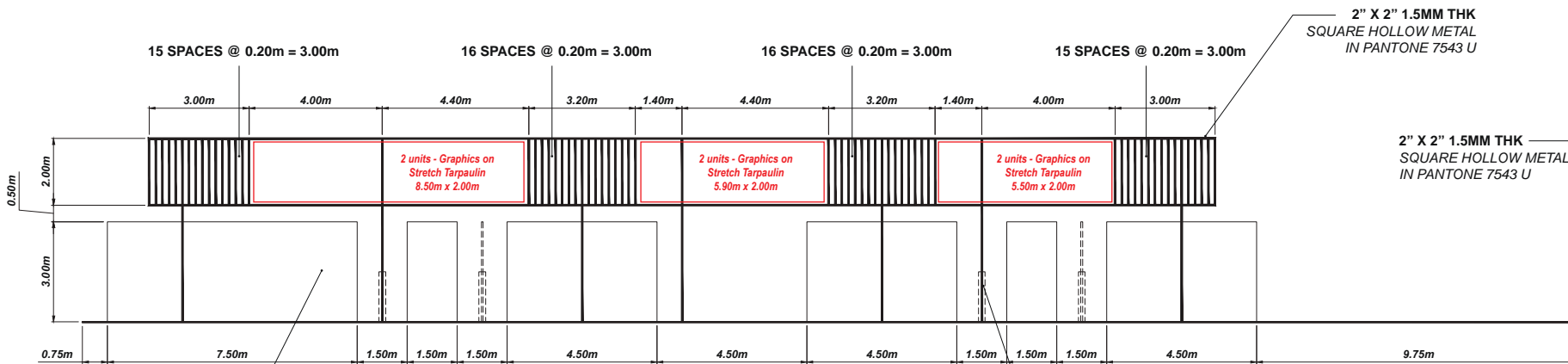

WOODEN WALLS IN 3/4 PLYWOOD IN PANTONE 2455 U

ELEVATION A3



WOODEN PARTITION 3/4 PLYWOOD IN PANTONE 9241 U

WOODEN PARTITION 3/4 PLYWOOD IN PANTONE 9241 U

ELEVATION A4

	PROJECT:	CIE 2019	CONTENT:	DETAILS	
	TITLE:	COMMODITY PAVILION	DESIGNER:	MIR	
DATE:	10/10/2019	REVISION:	01	LOCATION:	SHANGHAI, CHINA
				SHEET NO:	5

DETAILS

COMMODITY OVERHEAD -03

NOTE: TABLE, CHAIRS AND LOUNGE AREA ARE NOT SHOWN FOR CLARITY



**3/4" PLYWOOD
PLANKS FLOORING
(9.00m x 10.00m)**

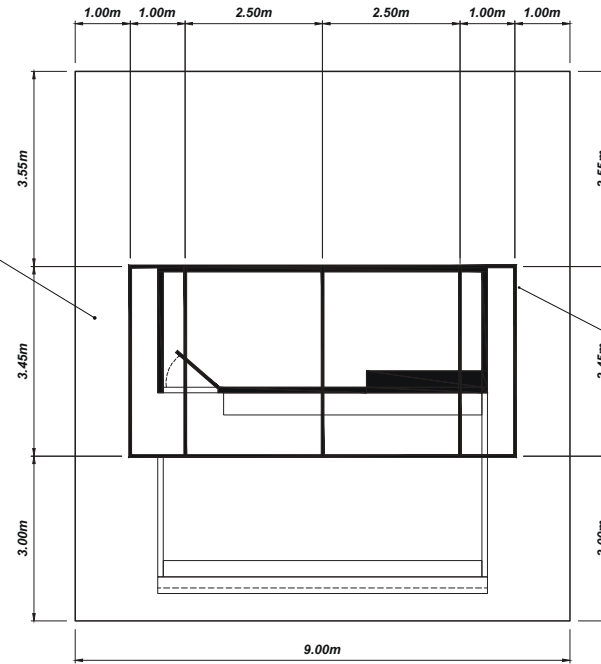

TOP VIEW

**2" X 2" 1.5MM THK
SQUARE HOLLOW METAL
IN PANTONE 7543 U**



**TYPICAL FINISH FOR
ALL METAL BARS
2" X 2" 1.5MM THK
SQUARE HOLLOW METAL
IN PANTONE 7543 U**

**2" X 2" 1.5MM THK
SQUARE HOLLOW METAL
IN PANTONE 7543 U**

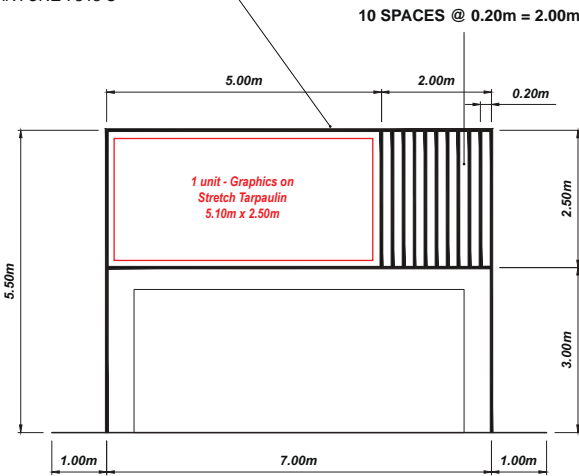

REAR VIEW

10 SPACES @ 0.20m = 2.00m

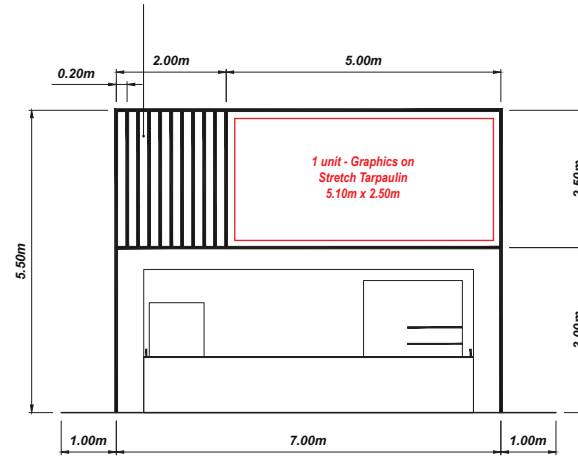

FRONT VIEW

**2" X 2" 1.5MM THK
SQUARE HOLLOW METAL
IN PANTONE 7543 U**

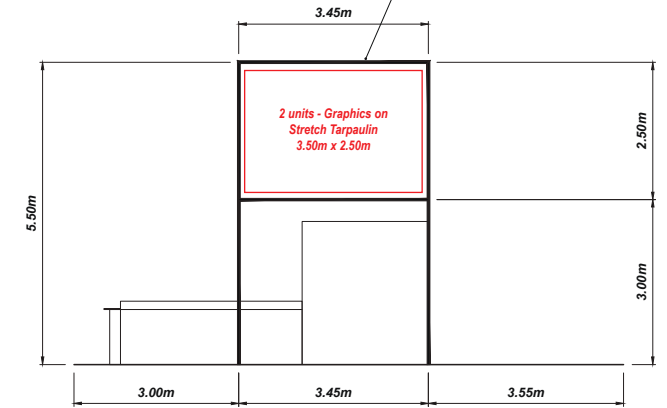

RIGHT SIDE VIEW

	PROJECT:	CIE 2019	CONTENT:	DETAILS	
	TITLE:	COMMODITY PAVILION	DESIGNER:	MIR	
DATE:	10/10/2019	REVISION:	01	LOCATION:	SHANGHAI, CHINA
			SHEET NO.:	6	

DETAILS

COOKING COUNTER

NOTE: PAVILION OVERHEAD ARE NOT SHOWN FOR CLARITY

**VINYL STICKER
OAK STRIP CHARCOAL**

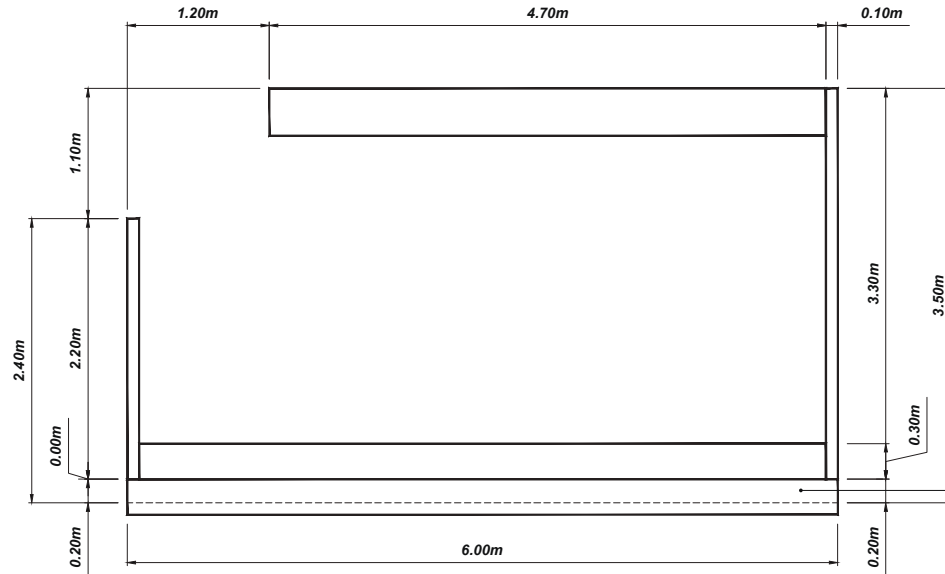

WOODEN TOP
3/4 PLYWOOD IN
PANTONE 2455 U



5MM SNEEZE GUARD GLASS

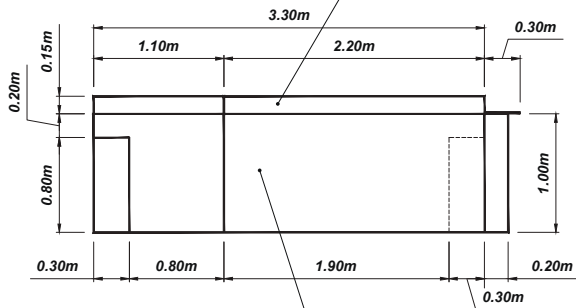

**3/4 PYLWOOD IN
VINYL STICKER
OAK STRIP CHARCOAL**

5MM SNEEZE GUARD GLASS

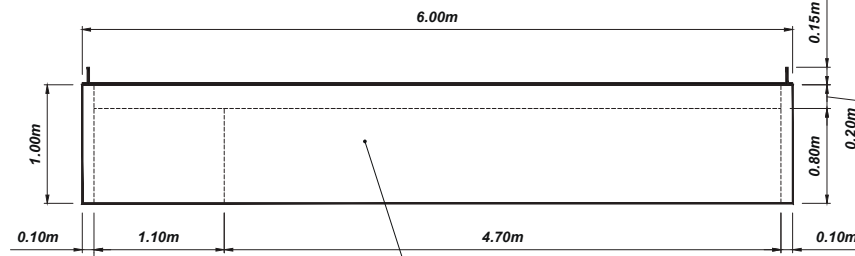

**3/4 PYLWOOD IN
VINYL STICKER
OAK STRIP CHARCOAL**

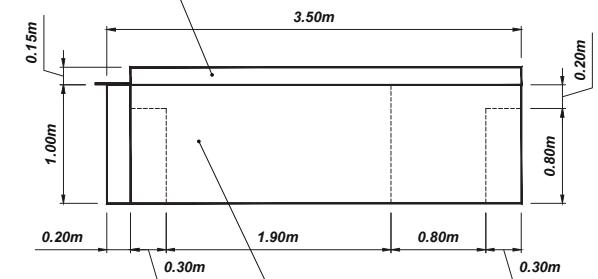

**3/4 PYLWOOD IN
VINYL STICKER
OAK STRIP CHARCOAL**

<p>EXHIBITION AND DESIGN DIVISION</p>	PROJECT:	CIIE 2019	CONTENT:	DETAILS	
	TITLE:	COMMODITY PAVILION	DESIGNER:	MIR	
DATE:	10/10/2019	REVISION:	01	LOCATION:	SHANGHAI, CHINA
			SHEET NO.:	7	

DETAILS

PREPARATION AREA

NOTE: PAVILION OVERHEAD ARE NOT SHOWN FOR CLARITY

3/4 PYLWOOD IN VINYL STICKER OAK STRIP CHARCOAL

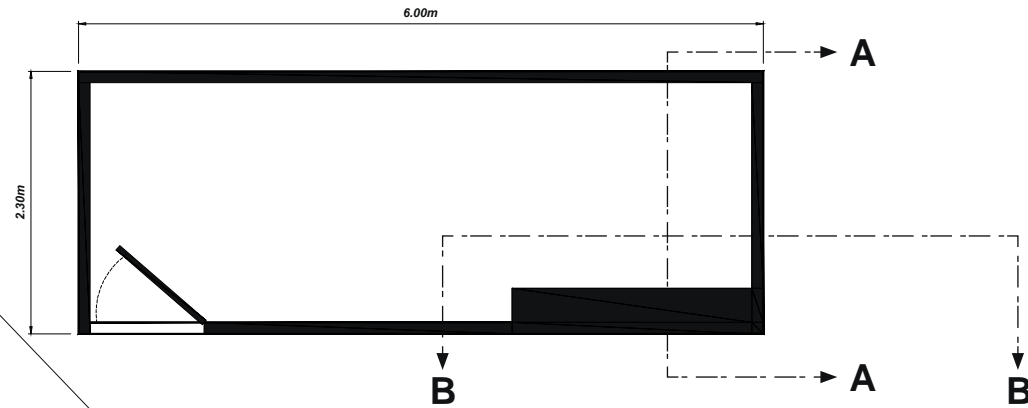

LOCKABLE CABINET

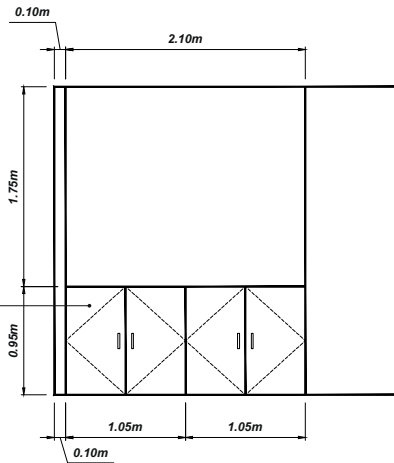

SECTION B-B

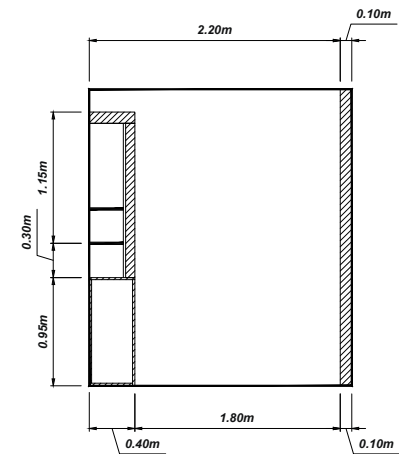
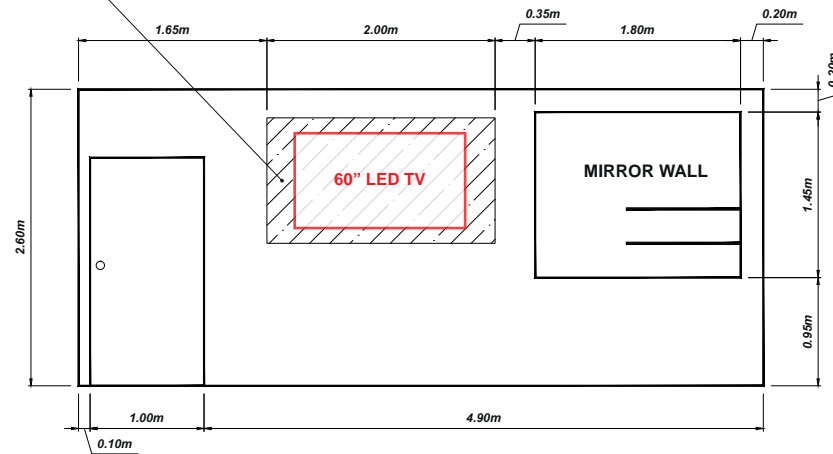

SECTION A-A

LETTER CUT-OUT
Backlighted wooden / PVC cut-out
0.85m x 2.50m x 2" THK



WOODEN WALL IN 3/4 PLYWOOD IN PANTONE 2455 U

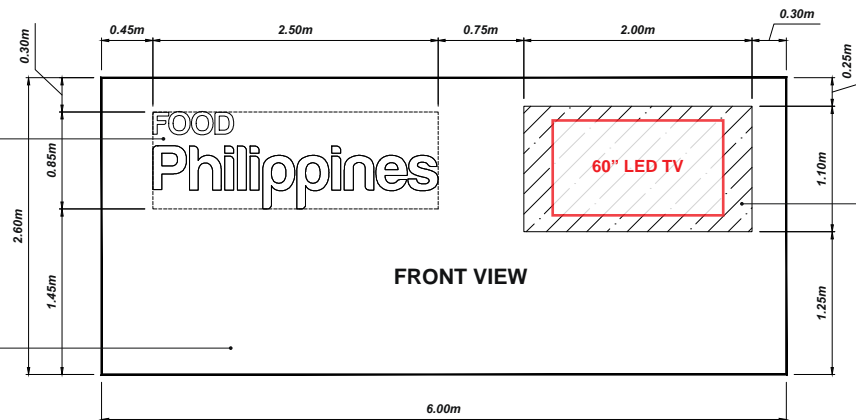

3/4 PYLWOOD IN VINYL STICKER OAK STRIP CHARCOAL



	PROJECT:	CIE 2019	CONTENT:	DETAILS	
	TITLE:	COMMODITY PAVILION	DESIGNER:	MIR	
DATE:	10/10/2019	REVISION:	01	LOCATION:	SHANGHAI, CHINA
				SHEET NO.:	8

DETAILS

TYPICAL 2.00m x 3.00m BOOTH

NOTE: OVERHEAD, TABLE, CHAIRS AND ARE NOT SHOWN FOR CLARITY

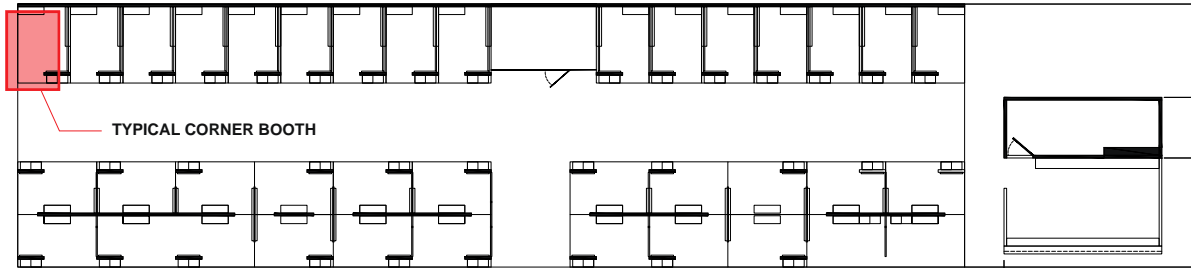

CORNER BOOTH



MIDDLE BOOTH



WOODEN WALLS IN
3/4 PLYWOOD IN
PANTONE 2455 U

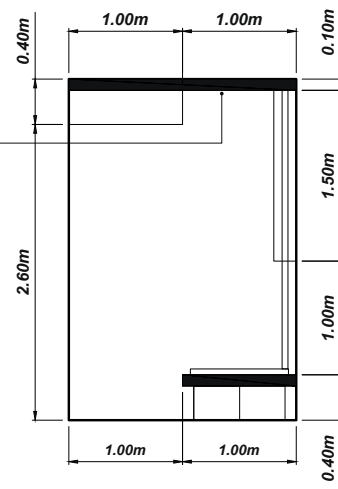

WOODEN PARTITION
3/4 PLYWOOD IN
PANTONE 9241 U

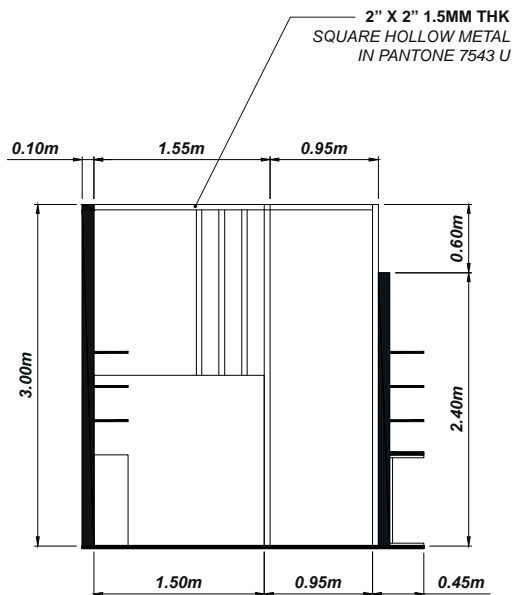

2" X 2" 1.5MM THK
SQUARE HOLLOW METAL
IN PANTONE 7543 U

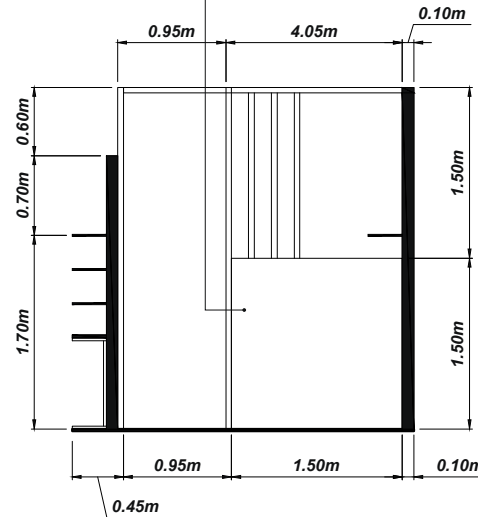
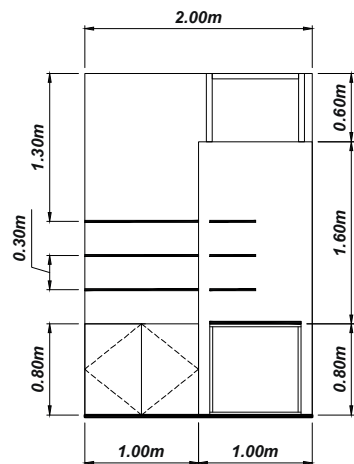

	PROJECT:	CIE 2019	CONTENT:	DETAILS	
	TITLE:	COMMODITY PAVILION	DESIGNER:	MIR	
DATE:	10/10/2019	REVISION:	01	LOCATION:	SHANGHAI, CHINA
				SHEET NO.:	9

DETAILS

TYPICAL 3.00m x 2.00m BOOTH

NOTE: OVERHEAD, TABLE, CHAIRS AND ARE NOT SHOWN FOR CLARITY

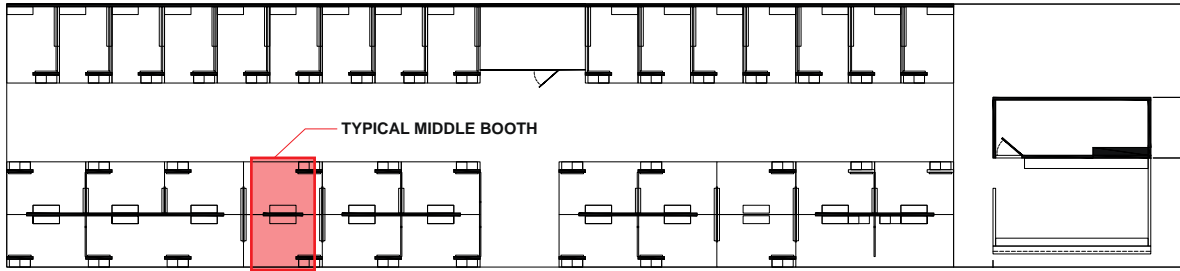

WOODEN WALLS IN
3/4 PLYWOOD IN
PANTONE 2455 U

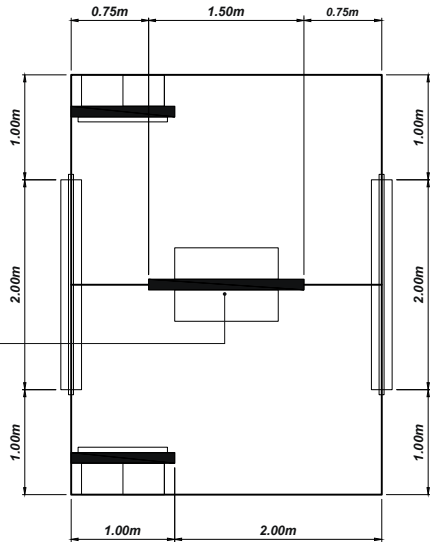

WOODEN PARTITION
3/4 PLYWOOD IN
PANTONE 9241 U



2" X 2" 1.5MM THK
SQUARE HOLLOW METAL
IN PANTONE 7543 U

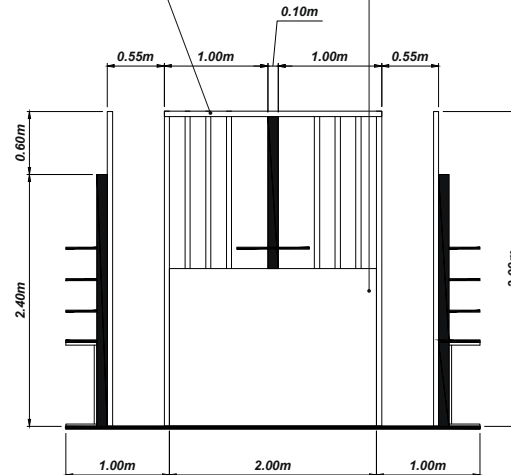
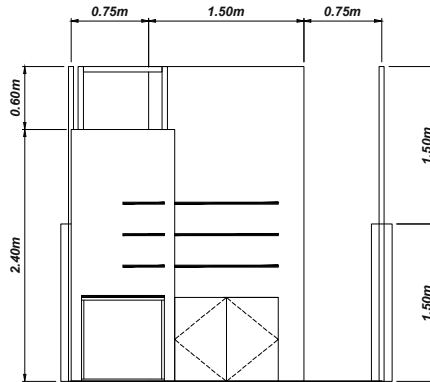

CORNER BOOTH



MIDDLE BOOTH



 EXHIBITION AND DESIGN DIVISION	PROJECT:	CIE 2019	CONTENT:	DETAILS	
	TITLE:	COMMODITY PAVILION	DESIGNER:	MIR	
DATE:	10/10/2019	REVISION:	01	LOCATION:	SHANGHAI, CHINA
				SHEET NO.:	10

DETAILS

CUSTOM BOOTH A - 9.00m x 2.00m

NOTE: OVERHEAD, TABLE, CHAIRS AND ARE NOT SHOWN FOR CLARITY

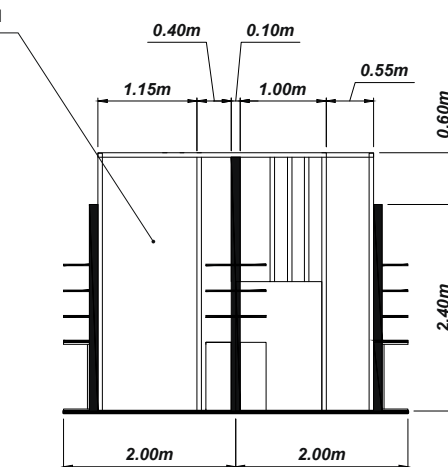
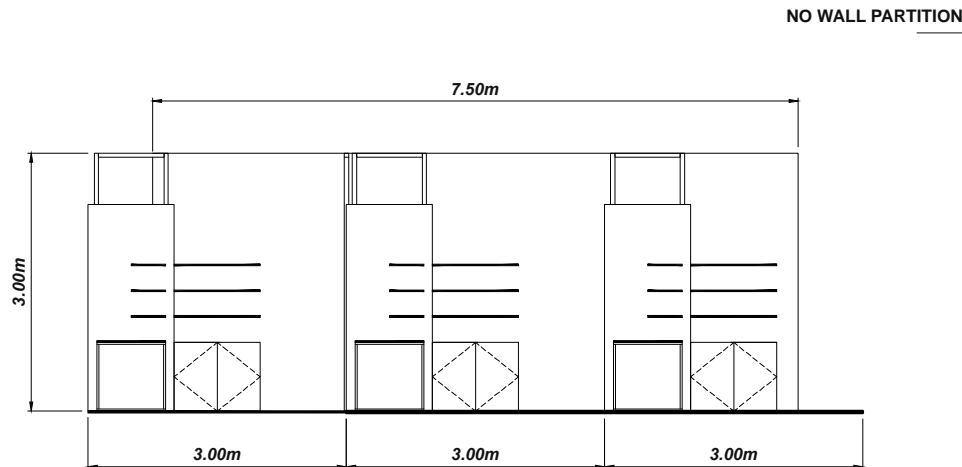
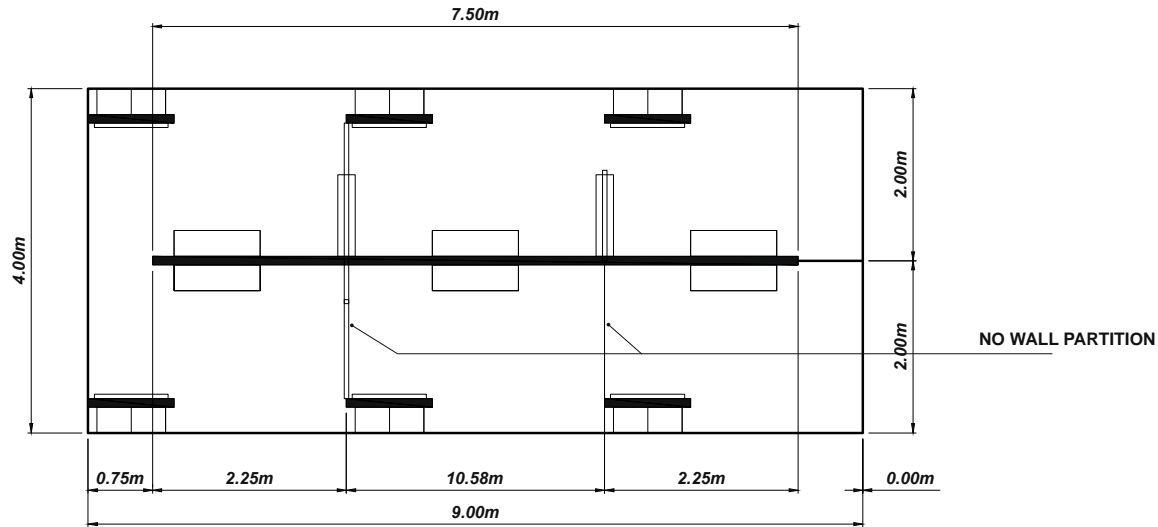
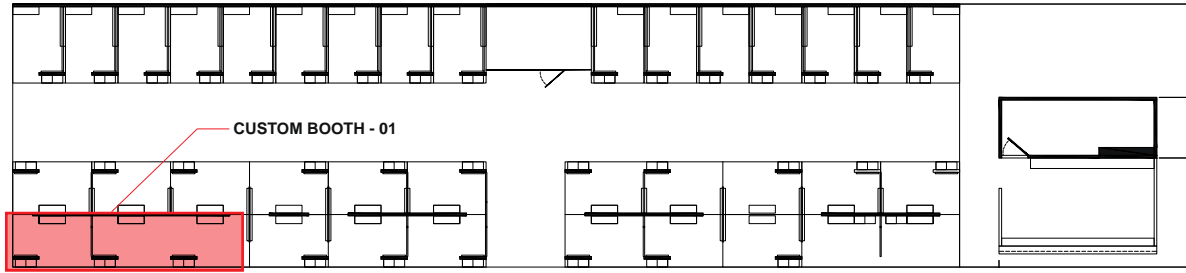

TYPICAL 12-18 SQ.M. BOOTH

	PROJECT:	CIE 2019	CONTENT:	DETAILS	
	TITLE:	COMMODITY PAVILION	DESIGNER:	MIR	
DATE:	10/10/2019	REVISION:	01	LOCATION:	SHANGHAI, CHINA
				SHEET NO.:	11

DETAILS

CUSTOM BOOTH B - 6.00m x 2.00m

NOTE: OVERHEAD, TABLE, CHAIRS AND ARE NOT SHOWN FOR CLARITY

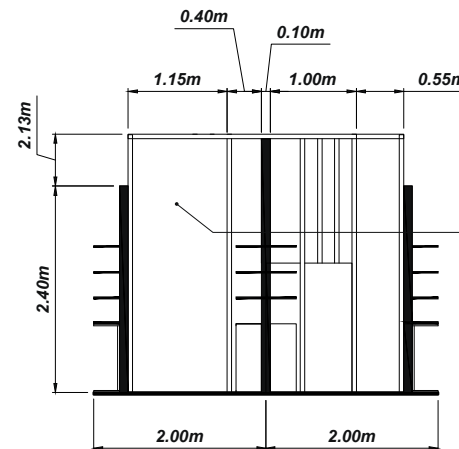
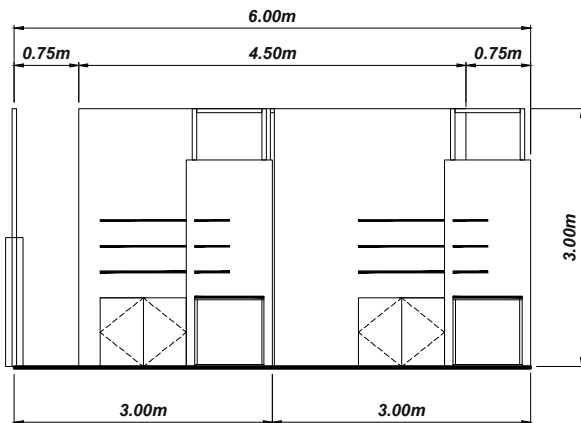
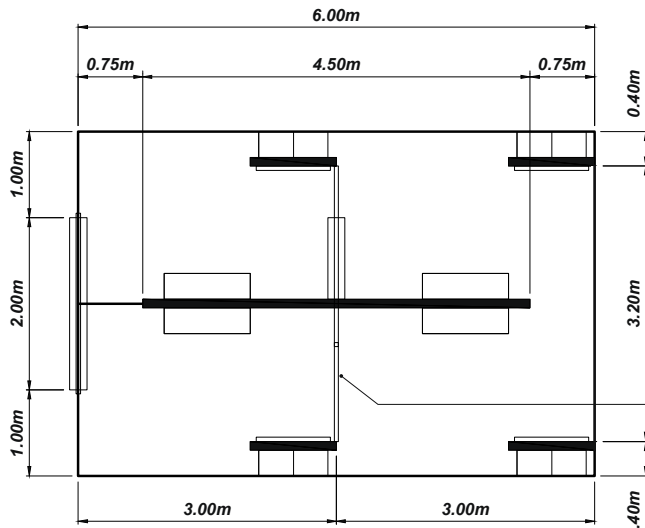
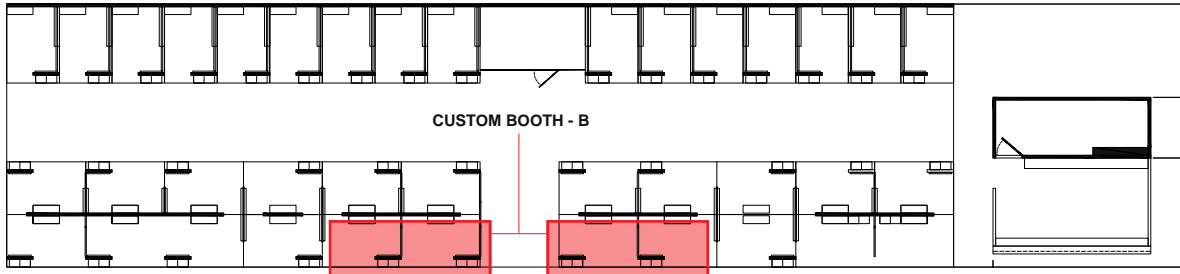

	PROJECT:	CIIE 2019	CONTENT:	DETAILS	
	TITLE:	COMMODITY PAVILION	DESIGNER:	MIR	
DATE:	10/10/2019	REVISION:	01	LOCATION:	SHANGHAI, CHINA
				SHEET NO.:	12

DETAILS

CUSTOM BOOTH C - 6.00m x 2.00m

NOTE: OVERHEAD, TABLE, CHAIRS AND ARE NOT SHOWN FOR CLARITY

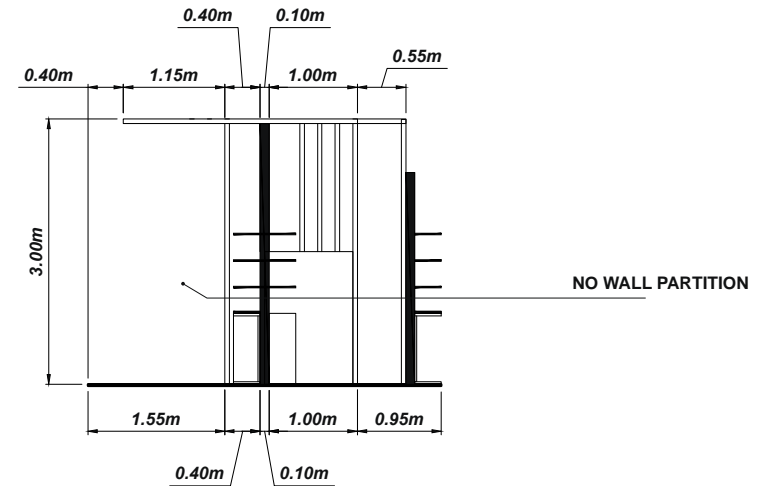
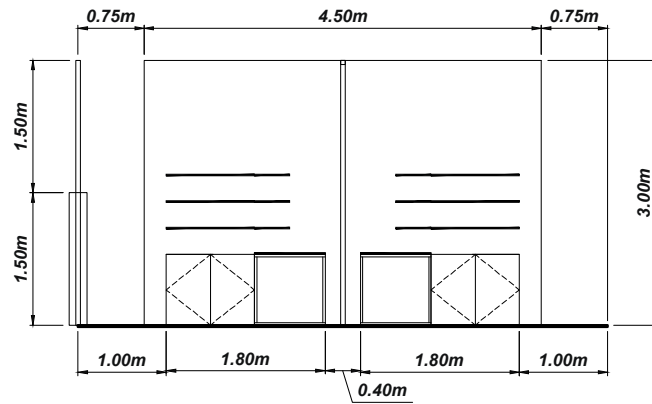
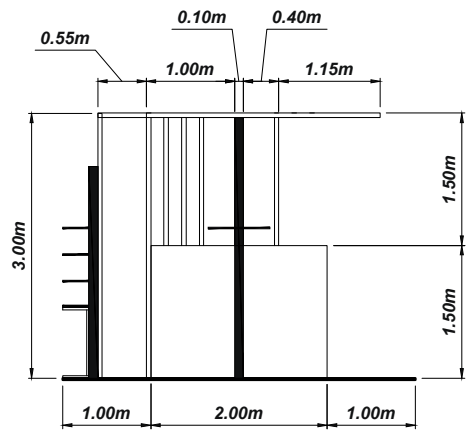
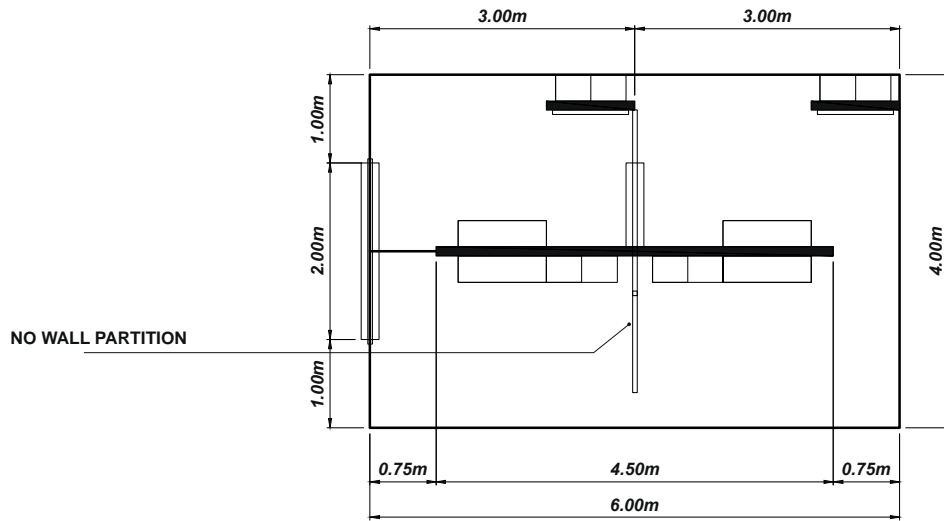
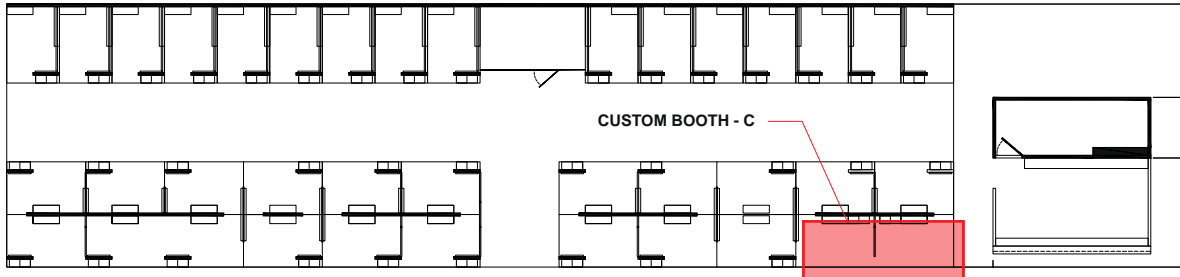

	PROJECT:	CIE 2019	CONTENT:	DETAILS	
	TITLE:	COMMODITY PAVILION	DESIGNER:	MIR	
DATE:	10/10/2019	REVISION:	01	LOCATION:	SHANGHAI, CHINA
				SHEET NO:	13

DETAILS

CUSTOM BOOTH D - 4.00m x 3.00m

NOTE: OVERHEAD, TABLE, CHAIRS AND ARE NOT SHOWN FOR CLARITY

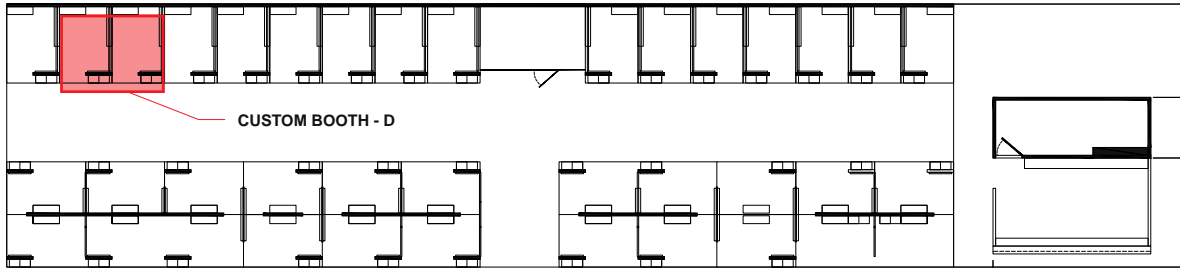

CORNER BOOTH

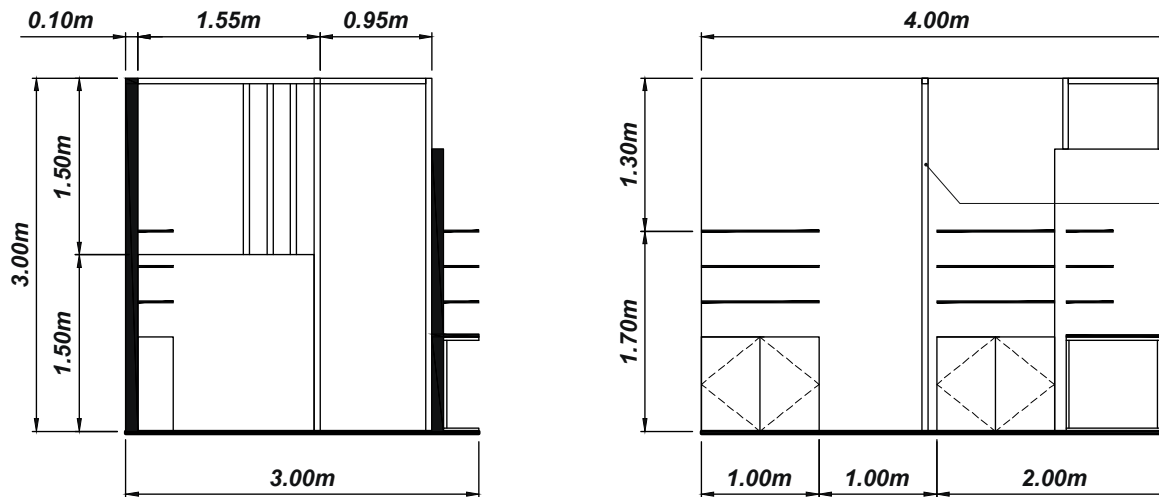
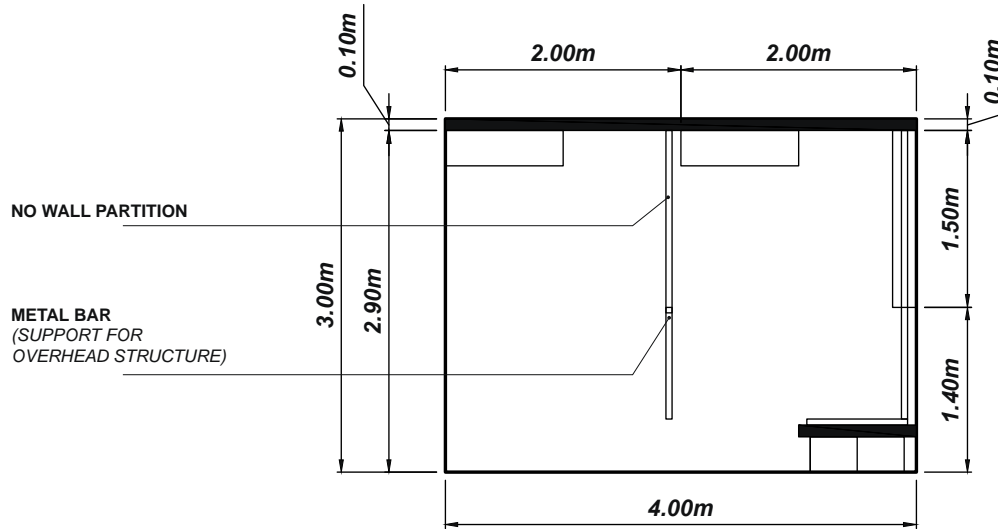

METAL BAR
(SUPPORT FOR
OVERHEAD STRUCTURE)

	PROJECT:	CIIE 2019	CONTENT:	DETAILS	
	TITLE:	COMMODITY PAVILION	DESIGNER:	MIR	
DATE:	10/10/2019	REVISION:	01	LOCATION:	SHANGHAI, CHINA
				SHEET NO:	14

DETAILS

EXHIBITORS DISPLAY

NOTE: OVERHEAD, TABLE, CHAIRS AND ARE NOT SHOWN FOR CLARITY

EXHIBITORS DISPLAY-01
38 SETS

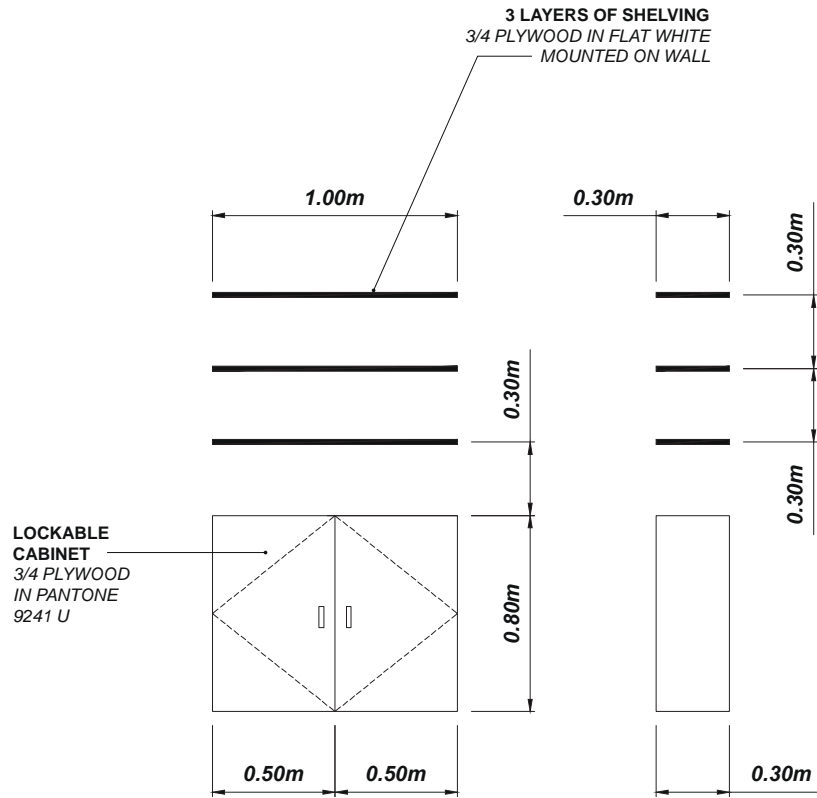

EXHIBITORS DISPLAY-02
37 SETS

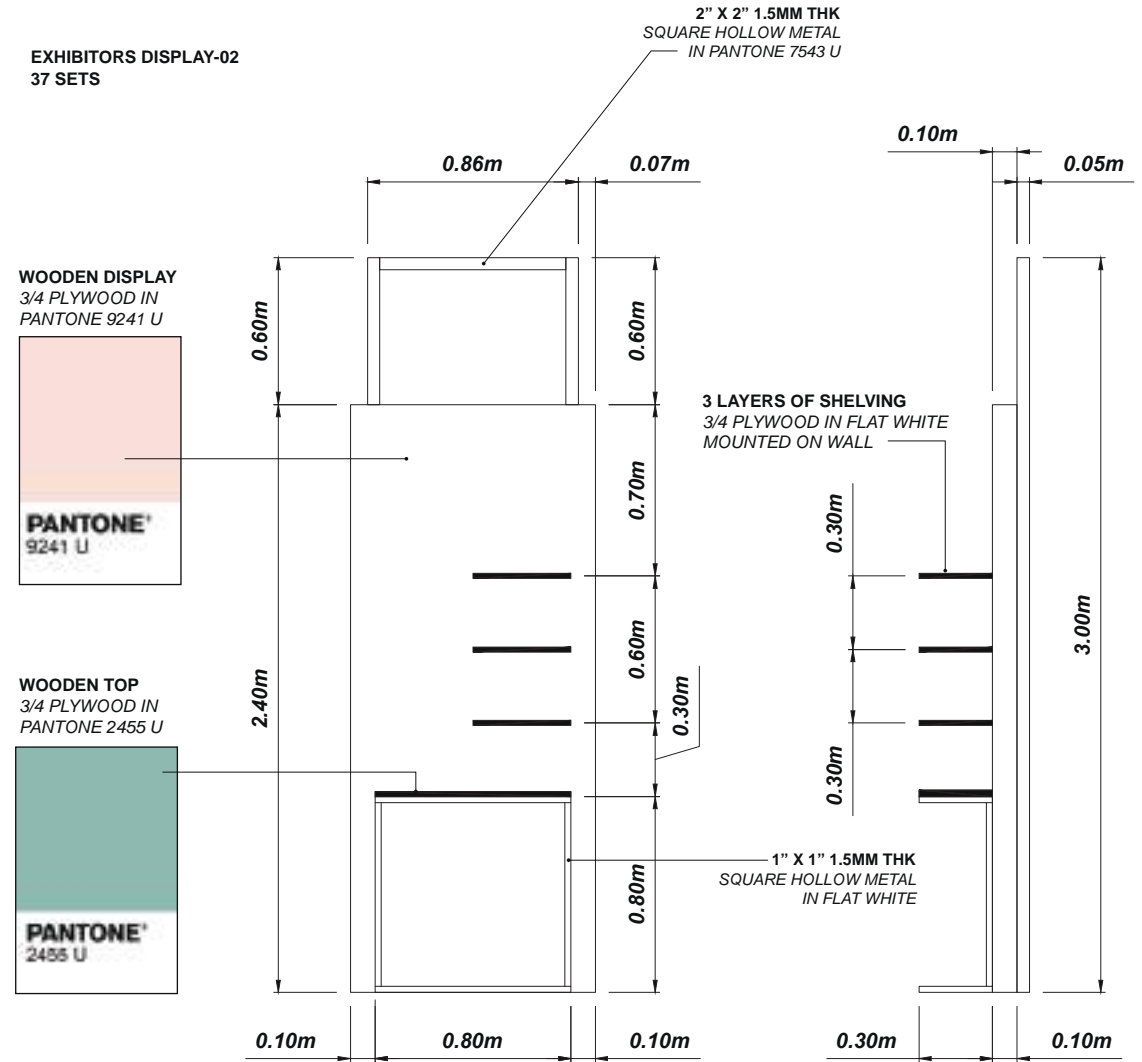

 EXHIBITION AND DESIGN DIVISION	PROJECT:	CIE 2019	CONTENT:	DETAILS	
	TITLE:	COMMODITY PAVILION	DESIGNER:	MIR	
DATE:	10/10/2019	REVISION:	01	LOCATION:	SHANGHAI, CHINA
			SHEET NO.:	15	

DETAILS

LOUNGE COMPONENTS

NOTE: OVERHEAD, TABLE, CHAIRS AND ARE NOT SHOWN FOR CLARITY

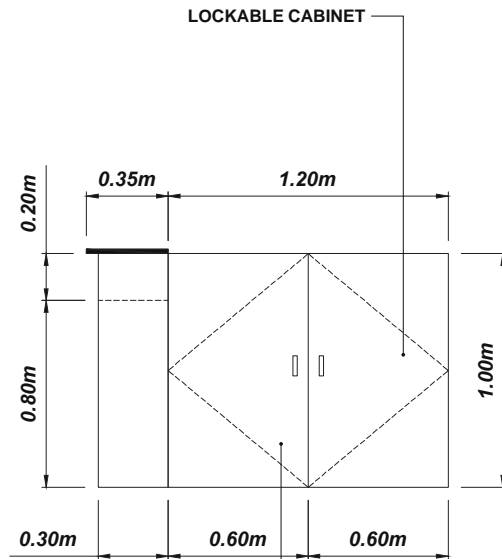
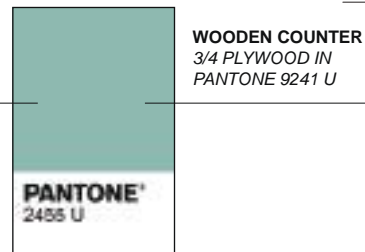
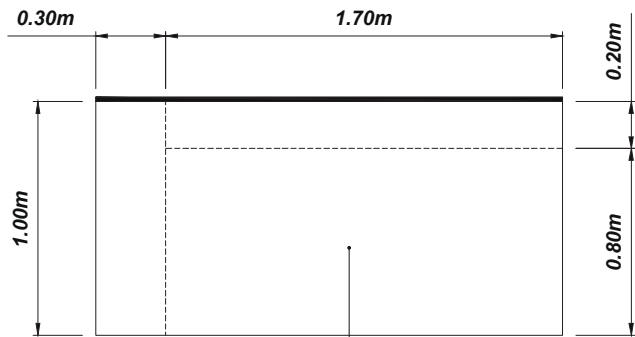
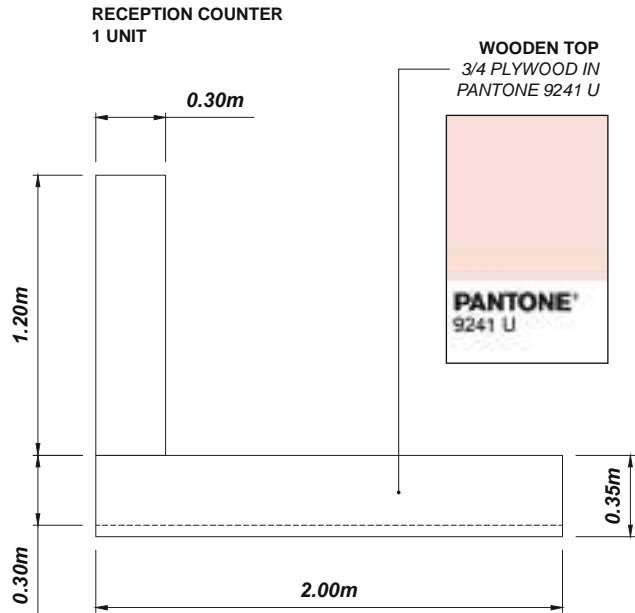

**LOCKABLE CABINET
1 UNIT**

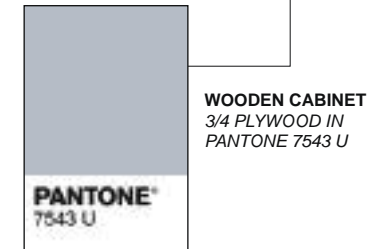
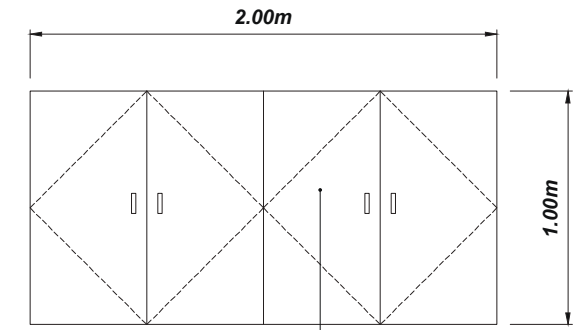
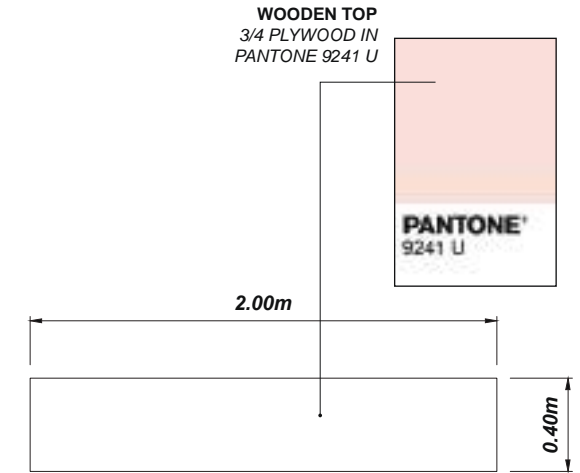

 EXHIBITION AND DESIGN DIVISION	PROJECT:	CIIE 2019	CONTENT:	DETAILS	
	TITLE:	COMMODITY PAVILION	DESIGNER:	MIR	
DATE:	10/10/2019	REVISION:	01	LOCATION:	SHANGHAI, CHINA
			SHEET NO.:	16	

DETAILS

STORAGE AREA

NOTE: OVERHEAD, TABLE, CHAIRS AND ARE NOT SHOWN FOR CLARITY

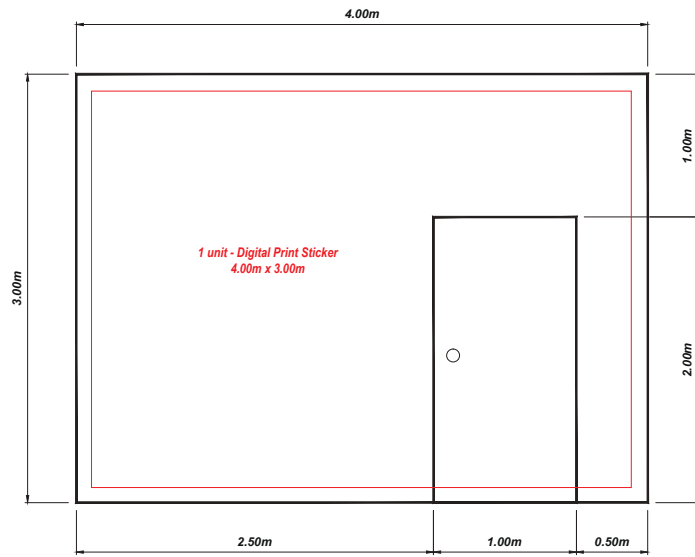
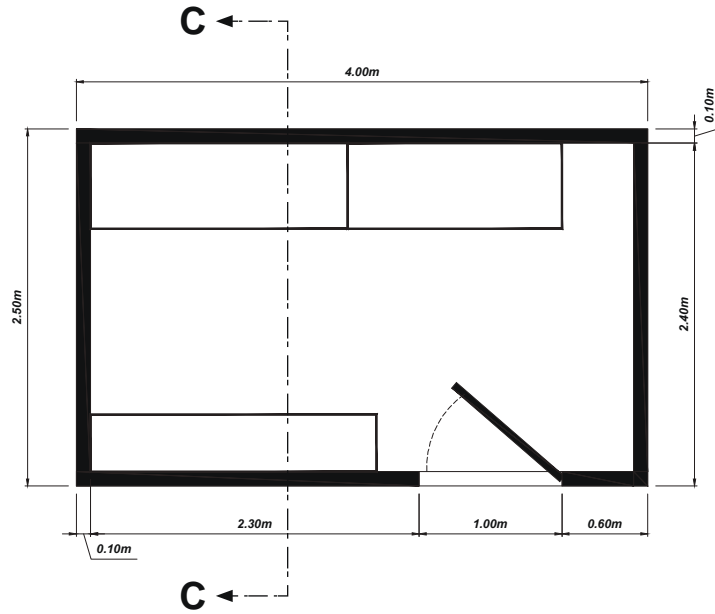

FRONT VIEW

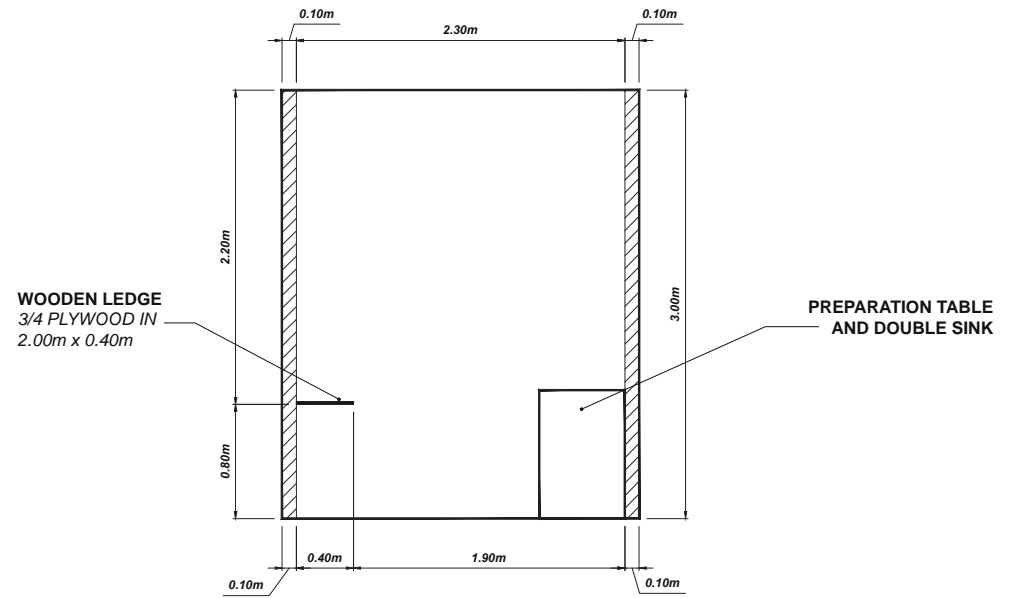

SECTION C-C

	PROJECT:	CIIE 2019	CONTENT:	DETAILS	
	TITLE:	COMMODITY PAVILION	DESIGNER:	MIR	
DATE:	10/10/2019	REVISION:	01	LOCATION:	SHANGHAI, CHINA
				SHEET NO:	17

LIGHTING PLAN

NOTE: TABLE, CHAIRS AND ARE NOT SHOWN FOR CLARITY

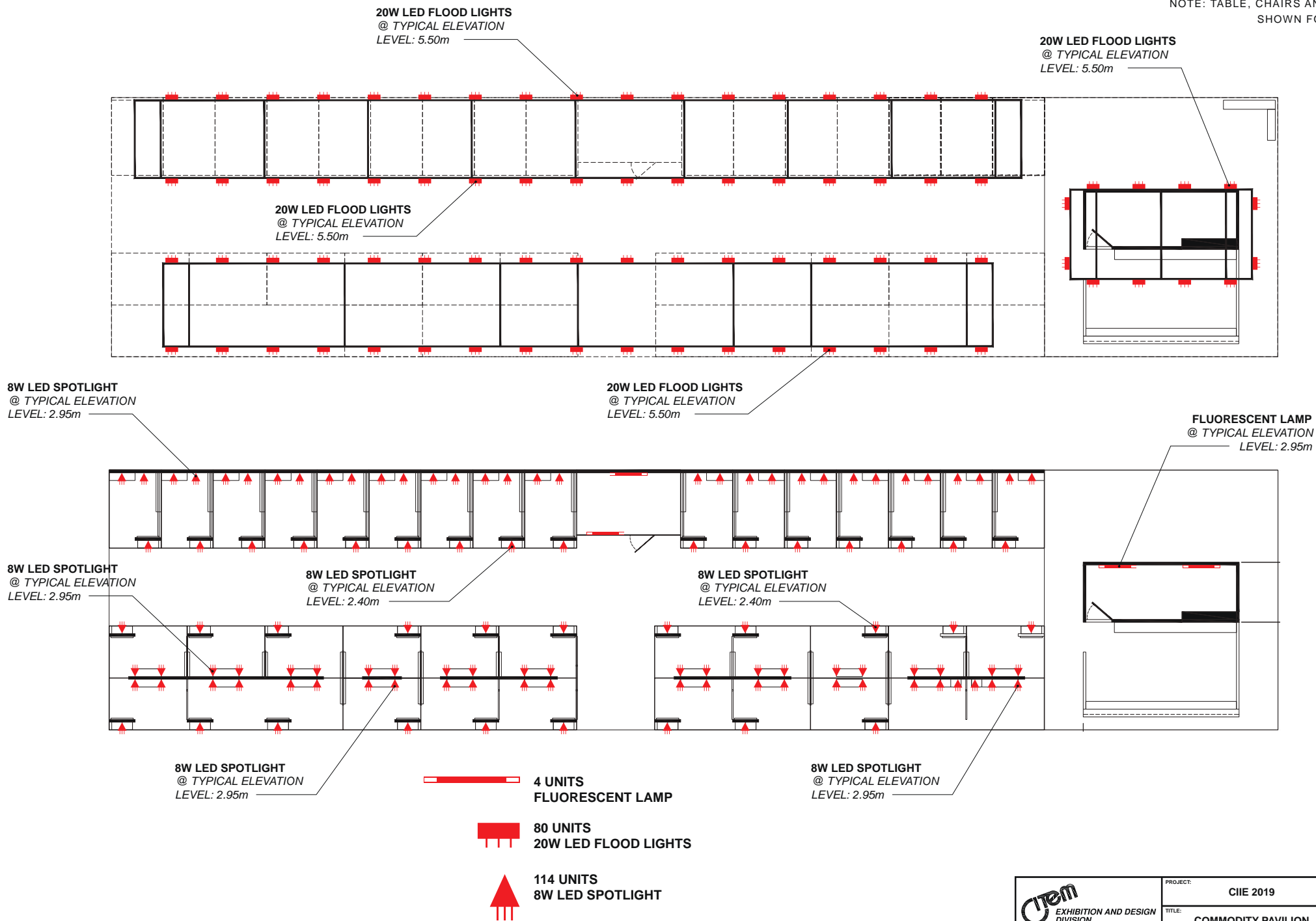

 EXHIBITION AND DESIGN DIVISION	PROJECT:	CIE 2019	CONTENT:	DETAILS	
	TITLE:	COMMODITY PAVILION	DESIGNER:	MIR	
DATE:	10/10/2019	REVISION:	01	LOCATION:	SHANGHAI, CHINA
			SHEET NO.:	18	

OUTLETS AND BREAKER

NOTE: TABLE, CHAIRS AND ARE NOT SHOWN FOR CLARITY

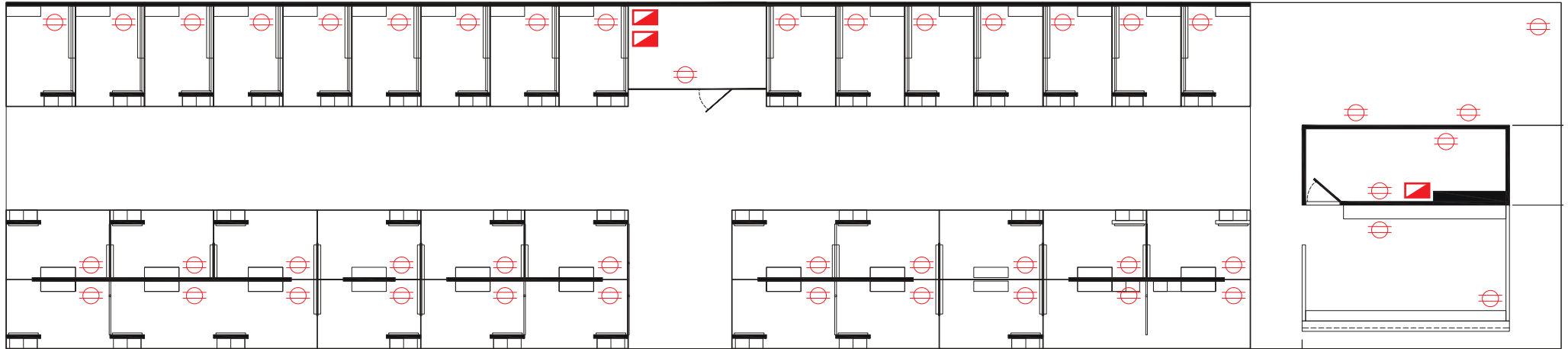

 3 UNITS
CIRCUIT BREAKER (CONTRACTOR TO PROVIDE RATING)

 46 UNITS
2 GANG CONVENIENCE OUTLET

	PROJECT:	CIE 2019	CONTENT:	DETAILS			
	TITLE:	COMMODITY PAVILION	DESIGNER:	MIR			
DATE:	10/10/2019	REVISION:	01	LOCATION:	SHANGHAI, CHINA	SHEET NO.:	19

WATER CONNECTION

NOTE: TABLE, CHAIRS AND ARE NOT SHOWN FOR CLARITY

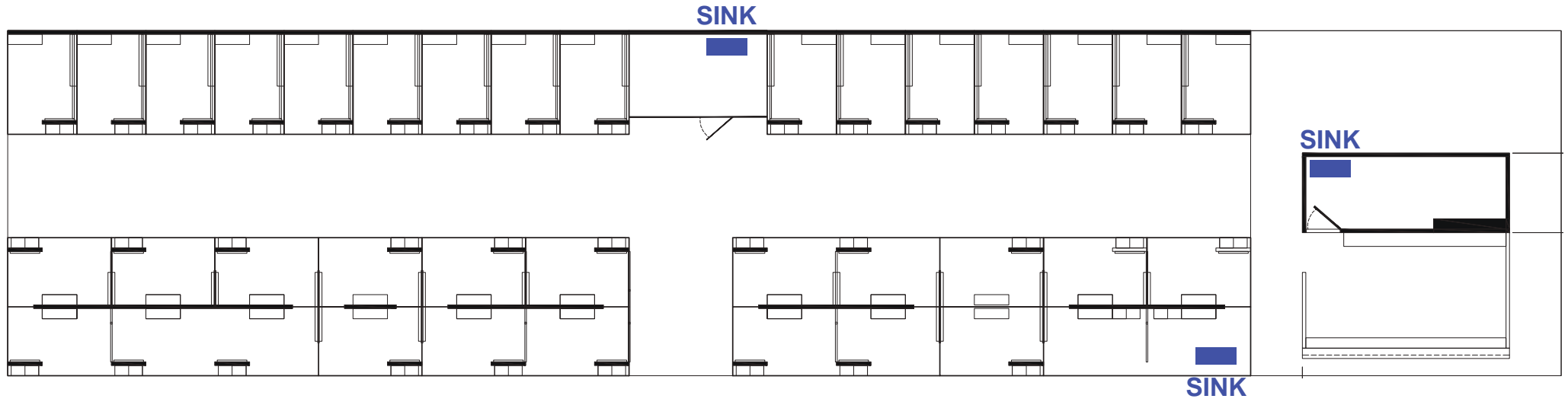

 EXHIBITION AND DESIGN DIVISION	PROJECT:	CIE 2019	CONTENT:	DETAILS			
	TITLE:	COMMODITY PAVILION	DESIGNER:	MIR			
DATE:	10/10/2019	REVISION:	01	LOCATION:	SHANGHAI, CHINA	SHEET NO.:	20

STEEL TABLE - 1 UNIT

Stainless Steel Table - 1.8m

Stainless Steel Table 1.8m	
CODE	H20C
 Dimensions (WxDxH)	1800x600x900

- Height adjustable steel undershelf



DOUBLE SINK - 1 UNIT

Stainless Steel Sink - Double Bowl

Stainless Steel Sink, Double Bowl and Draining Board	
CODE	H21B
 Dimensions (WxDxH)	1500x600x900
 Water inlet/drain	in 1/2" BSP - out 40mm diam

- Complete with undershelf
- Rear upstand and raised lip
- Angled draining rack



 EXHIBITION AND DESIGN DIVISION	PROJECT:	CIE 2019	CONTENT:	DETAILS	
	TITLE:	COMMODITY PAVILION	DESIGNER:	MIR	
DATE:	10/10/2019	REVISION:	01	LOCATION:	SHANGHAI, CHINA
			SHEET NO.:	21	

L SHAPE SOFA - 1 UNIT

https://www.alibaba.com/product-detail/Upholstered-Arm-lazy-furniture-sectional-home_62021947707.html?spm=a2700.galleryofferlist.normalList.234.60f94207tj9FHh



View larger image



Add to Compare Share

Upholstered Arm lazy furniture sectional home sofa set home living room sofa

FOB Reference Price: [Get Latest Price](#)

US\$58.00 - US\$88.00 / Pieces : 10 Piece/Pieces (Min. Order)

Color:



Lead Time:

Quantity(Pieces)	1 - 1000	>1000
Est. Time(days)	20	Negotiable

Contact Supplier

Chat Now

Seller Support: Trade Assurance protect your orders from payment to delivery

Payments: More

Shipping: Alibaba.com Ocean Shipping Service from China to U.S
[Get shipping quote](#)



Wuxi More Design Furniture Co., Ltd.

3 YRS

Manufacturer, Trading Company

Gold Supplier

Trade Assurance

Onsite Check

5.0 Very satisfied
13 Reviews

Transaction Level

26 Transactions \$ 110,000+

Response Time <24h

Response Rate 90%

[View Company Profile](#)

You may like



Wholesale cheap indoor furniture wood

	PROJECT:	CIE 2019	CONTENT:	DETAILS	
	TITLE:	COMMODITY PAVILION	DESIGNER:	MIR	
DATE:	10/10/2019	REVISION:	01	LOCATION:	SHANGHAI, CHINA
				SHEET NO.:	22

COFFEE TABLE - 1 UNIT

https://www.alibaba.com/product-detail/Teak-Centre-Coffee-Table-With-solid_62164656393.html?spm=a2700.galleryofferlist.normalList.268.465f600buzE9tf



[View larger image](#)



Add to Compare Share

Teak Centre Coffee Table With solid wood Leg Living Room Furniture

FOB Reference Price: [Get Latest Price](#)

US\$53.00 - US\$62.00 / Sets | 1 Set/Sets (Min. Order)

Color:



Size:

1200W*600D*450H MM [All 2 Options](#) v

Lead Time:

Quantity(Sets)	1 - 3	>3
Est. Time(days)	7	Negotiable

Customization: Customized logo (Min. Order: 100 Sets)
Customized packaging (Min. Order: 100 Sets) [More](#) v

[Contact Supplier](#)

Samples - US\$53.00 / Sets, 1 Sets (Min. Order); [Buy Samples](#)

[Chat Now](#)



Foshan JUOU
Furniture
Manufacturing Co.,
Ltd.

1 YR CN

Gold Supplier

Trade Assurance

Onsite Check

Transaction Level:

5 Transactions 70,000+

Response Time <24h

Response Rate 96.1%

[View Company Profile](#)

You may like



designer coffee table
coffee table set coffee
US\$64.00 - US\$74.50



	PROJECT:	CIE 2019	CONTENT:	DETAILS	
	TITLE:	COMMODITY PAVILION	DESIGNER:	MIR	
DATE:	10/10/2019	REVISION:	01	LOCATION:	SHANGHAI, CHINA
				SHEET NO.:	23

BAR STOOL - 2 UNITS

https://www.alibaba.com/product-detail/Counter-stools-Used-Commercial-Bar-Stools_60692560823.html?spm=a2700.galleryofferlist.normalList.69.28bd24cbMRmcM1



[View larger image](#)





[Add to Compare](#) [Share](#)

Counter stools Used Commercial Bar Stools counter height stools

2 - 40 Pieces	>=50 Pieces
US\$40.00	US\$38.00

Size:

Customization: Customized logo (Min. Order: 100 Pieces)
 Customized packaging (Min. Order: 100 Pieces) [More](#)

[Contact Supplier](#)

Samples - US\$120.00 /Pieces, 1 Pieces (Min. Order) [Buy Samples](#)

[Chat Now](#)

Selfer Support: Trade Assurance protect your orders from payment to delivery.

Payments: [WISA](#) [TT](#) [Online Bank Payment](#) [Pay Later](#) [More](#)

Shipping: Alibaba.com Ocean Shipping Service from China to U.S
[Get shipping quote](#)

Foshan Shunde Huaquan Furniture Co., Ltd.

6 YRS **CN**

Manufacturer, Trading Company

Verified Supplier

- Assessed video
- Panoramic pictures
- Factory inspection reports
- Verified production lines

Trade Assurance

4.5 vs **Satisfied**
 6 Reviews

Transaction Level

33 Transactions \$ 210,000+

Response Time <24h

Response Rate 90.5%

Top 3 Markets:







 EXHIBITION AND DESIGN DIVISION	PROJECT: CIIE 2019	CONTENT: DETAILS
	TITLE: COMMODITY PAVILION	DESIGNER: MIR
DATE: 10/10/2019	REVISION: 01	LOCATION: SHANGHAI, CHINA
		SHEET NO: 24

LONG TABLE - 1 UNIT

https://www.alibaba.com/product-detail/simple-and-popular-MDF-wooden-DINING_62081782139.html?spm=a2700.galleryofferlist.normalList.254.26f31067648iAK



[View larger image](#)









[Add to Compare](#) [Share](#)

simple and popular MDF wooden DINING TABLE Dining Room Furniture 2 colours.

>> 300 Pieces
US\$25.59

Size:

Color: 

Lead Time:	Quantity(Pieces)	1- 1000	>1000
	Est. Time(days)	45	Negotiable



Customization: Customized logo (Min. Order: 300 Pieces)
Customized packaging (Min. Order: 300 Pieces) [More](#)

[Contact Supplier](#)

Samples: US\$25.59 / Pieces, 1 Pieces (Min. Order): [Buy Samples](#)

[Chat Now](#)

Seller Support:  Trade Assurance (protect your orders from payment to delivery)

Payments:    [Online Bank Payment](#) [Pay Later](#) [More](#)

Shipping: Alibaba.com Ocean Shipping Service from China to U.S
[Get shipping quote](#)





Fuzhou Homefield Furniture Co., Ltd.

2 YRS  CN



Trading Company

 Gold Supplier

 Trade Assurance

 Onsite Check

5.0  Very satisfied
2 Reviews

Transaction Level:   

6 Transactions  130,000+

Response Time:  <24h

Response Rate:  92.1%

[View Company Profile](#)

You may like



MDF dining table wood furniture dining
US\$26.34 / Piece
300 Pieces

 <p style="font-size: 0.7em; margin: 0;">EXHIBITION AND DESIGN DIVISION</p>	PROJECT:	CIIE 2019	CONTENT:	DETAILS
	TITLE:	COMMODITY PAVILION	DESIGNER:	MIR
DATE:	10/10/2019	REVISION:	01	LOCATION:
		SHANGHAI, CHINA	SHEET NO.:	25

MODERN CHAIR - 8 UNITS

https://www.alibaba.com/product-detail/Modern-dining-chair-with-wooden-legs_60732826890.html?spm=a2700.galleryofferlist.normalList.338.744d7ce1fug3U5

	PROJECT:	CIE 2019	CONTENT:	DETAILS	
	TITLE:	COMMODITY PAVILION	DESIGNER:	MIR	
DATE:	10/10/2019	REVISION:	01	LOCATION:	SHANGHAI, CHINA
				SHEET NO.:	26

I. MAIN CONSTRUCTION / FABRICATION / INSTALLATION / DISMANTLING		TOTAL QTY.
I.A) PAVILION AISLE CARPET - BLACK NEEDLE PUNCH	SEE DETAILS	122 SQ.M.
I.B) PAVILION EXHIBITORS CARPET - BEIGE NEEDLE PUNCH	SEE DETAILS	228 SQ.M.
I.B) PLYWOOD PLANKS FLOORING (9.00m x 10.00m)	SEE DETAILS	90 SQ.M.
I.C) PAVILION STRUCTURE / WALLS (3/4" THK Plywood with 2" x 2" KD framing)	SEE DETAILS	1 LOT
I.D) COMMODITY OVERHEAD 01 & 02 (2" x 2" - 1.5mm THK Square hollow metal in Pantone 7543 U)	SEE DETAILS	2 LOTS
I.E) COMMODITY OVERHEAD - 03 (2" x 2" - 1.5mm THK Square hollow metal in Pantone 7543 U)	SEE DETAILS	1 LOT
I.F) COOKING COUNTER (3/4" THK Plywood with 2" x 2" KD framing)	SEE DETAILS	1 LOT
I.G) PREPARATION AREA (3/4" THK Plywood with 2" x 2" KD framing)	SEE DETAILS	1 LOT
I.H) EXHIBITORS DISPLAY - 01	SEE DETAILS	38 UNITS
I.I) EXHIBITORS DISPLAY - 02	SEE DETAILS	37 UNITS
I.J) RECEPTION COUNTER	SEE DETAILS	1 UNIT
I.K) LOCKABLE CABINET	SEE DETAILS	1 UNIT
I.L) STORAGE AREA	SEE DETAILS	1 LOT

III. FURNITURE RENTAL		TOTAL QTY.
III.A) L SHAPE SOFA	SEE DETAILS	1 UNIT
III.B) COFFEE TABLE	SEE DETAILS	1 UNIT
III.C) BARSTOOL	SEE DETAILS	2 UNITS
III.D) LONG TABLE	SEE DETAILS	1 UNIT
III.E) MODERN CHAIR	SEE DETAILS	8 UNITS
III.F) WHITE TOP ROUND TABLE - 60CM DIA.		38 UNITS
III.G) STACKABLE CHAIR (3 UNITS PER EXHIBITOR, 3 UNIT FOR STORAGE AREA)		117 UNITS

	PROJECT:	CIIE 2019	CONTENT:	DETAILS	
	TITLE:	COMMODITY PAVILION	DESIGNER:	MIR	
DATE:	10/10/2019	REVISION:	01	LOCATION:	SHANGHAI, CHINA
				SHEET NO.:	27

IV. EQUIPMENT, PROPS RENTAL & MANPOWER		TOTAL QTY.
IV.A) MEDIUM SIZE TRASH BIN WITH LID AND GARBAGE BAG (BLACK OR CHROME)		43 PCS.
IV.B) HOT AND COLD WATER DISPENSER (FLOOR STANDING)		3 UNITS
IV.C) WATER GALLON PER DAY (6 GAL./DAY)		24 GAL.
IV.D) COMMERCIAL COFFEE MAKER (80 TO 100 CUPS)		1 SET
IV.E) PAPER CUPS & STIRRER		600 CUPS/SET
IV.F) COFFEE BAG, CREAMER & SUGAR WITH CONDIMETS ORGANIZER (ANY BRAND)		6 BAGS
IV.G) STAINLESS STEEL SINK - DOUBLE BOWL	SEE DETAILS	1 UNIT
IV.H) STAINLESS STEEL TABLE	SEE DETAILS	1 UNIT
IV.I) 60" LED TV		2 UNITS
IV.J) SOUND SYSTEM		1 SET
IV.K) RIBBON CUTTING PEDESTAL		2 UNITS
IV.L) WATER AND WASTE WATER CONNECTION		1 LOT

V. GRAPHICS AND LETTER CUTOUTS		TOTAL QTY.
V.A) DIGITAL PRINT ON STRETCH TARPAULIN (6.50m x 2.00m)	COMMODITY OVERHEAD -01	2 UNITS
V.B) DIGITAL PRINT ON STRETCH TARPAULIN (7.50m x 2.00m)	COMMODITY OVERHEAD -01	2 UNITS
V.C) DIGITAL PRINT ON STRETCH TARPAULIN (4.70m x 2.00m)	COMMODITY OVERHEAD -01	2 UNITS
V.D) DIGITAL PRINT ON STRETCH TARPAULIN (5.10m x 2.00m)	COMMODITY OVERHEAD -01	2 UNITS
V.E) DIGITAL PRINT ON STRETCH TARPAULIN (8.50m x 2.00m)	COMMODITY OVERHEAD -02	2 UNITS
V.F) DIGITAL PRINT ON STRETCH TARPAULIN (5.90m x 2.00m)	COMMODITY OVERHEAD -02	2 UNITS
V.G) DIGITAL PRINT ON STRETCH TARPAULIN (5.50m x 2.00m)	COMMODITY OVERHEAD -02	2 UNITS
V.H) DIGITAL PRINT ON STRETCH TARPAULIN (5.10m x 2.00m)	COMMODITY OVERHEAD -03	2 UNITS
V.I) DIGITAL PRINT ON STRETCH TARPAULIN (3.50m x 2.00m)	COMMODITY OVERHEAD -03	2 UNITS
V.J) BACK LIGHTED LETTER CUT-OUT MOUNTED ON WOOD PANEL (0.85m x 2.50m)	LOUNGE AREA	1 UNIT
V.K) DIGITAL PRINT STICKER GRAPHICS ON FOAMBOARD (0.60m x 0.80m)	COMPANY LOGO	38 UNITS
V.L) DIGITAL PRINT STICKER GRAPHICS ON FOAMBOARD (1.00m x 0.30m)	COMPANY NAME	38 UNITS
V.M) DIGITAL PRINT STICKER GRAPHICS ON FOAMBOARD (4.00m x 3.00m)	STORAGE AREA	1 UNIT

	PROJECT:	CIIE 2019	CONTENT:	DETAILS	
	TITLE:	COMMODITY PAVILION	DESIGNER:	MIR	
DATE:	10/10/2019	REVISION:	01	LOCATION:	SHANGHAI, CHINA
			SHEET NO.:	28	