

# **PHILIPPINE BIDDING DOCUMENTS**

## **HIRING OF OFFICIAL BOOTH AND VENUE ENHANCEMENTS CONTRACTOR FOR MANILA FAME 2024**

Government of the Republic of the Philippines

**Sixth Edition  
July 2020**

# Table of Contents

<b>GLOSSARY OF ACRONYMS, TERMS, AND ABBREVIATIONS .....</b>	<b>2</b>
<b>SECTION I. INVITATION TO BID .....</b>	<b>4</b>
<b>SECTION II. INSTRUCTIONS TO BIDDERS .....</b>	<b>6</b>
1. SCOPE OF BID .....	6
2. FUNDING INFORMATION .....	6
3. BIDDING REQUIREMENTS .....	6
4. CORRUPT, FRAUDULENT, COLLUSIVE, AND COERCIVE PRACTICES .....	6
5. ELIGIBLE BIDDERS .....	6
6. ORIGIN OF GOODS .....	6
7. SUBCONTRACTS .....	7
8. PRE-BID CONFERENCE .....	7
9. CLARIFICATION AND AMENDMENT OF BIDDING DOCUMENTS .....	7
10. DOCUMENTS COMPRISING THE BID: ELIGIBILITY AND TECHNICAL COMPONENTS ....	7
11. DOCUMENTS COMPRISING THE BID: FINANCIAL COMPONENT .....	7
12. BID PRICES .....	7
13. BID AND PAYMENT CURRENCIES .....	8
14. BID SECURITY .....	8
15. SEALING AND MARKING OF BIDS .....	8
16. DEADLINE FOR SUBMISSION OF BIDS .....	8
17. OPENING AND PRELIMINARY EXAMINATION OF BIDS .....	8
18. DOMESTIC PREFERENCE .....	9
19. DETAILED EVALUATION AND COMPARISON OF BIDS .....	9
20. POST-QUALIFICATION .....	9
21. SIGNING OF THE CONTRACT .....	9
<b>SECTION III. BID DATA SHEET .....</b>	<b>10</b>
<b>SECTION IV. GENERAL CONDITIONS OF CONTRACT .....</b>	<b>13</b>
1. SCOPE OF CONTRACT .....	13
2. ADVANCE PAYMENT AND TERMS OF PAYMENT .....	13
3. PERFORMANCE SECURITY .....	13
4. INSPECTION AND TESTS .....	13
5. WARRANTY .....	13
6. LIABILITY OF THE SUPPLIER .....	14
<b>SECTION V. SPECIAL CONDITIONS OF CONTRACT .....</b>	<b>15</b>
<b>SECTION VI. SCHEDULE OF REQUIREMENTS .....</b>	<b>17</b>
<b>SECTION VII. TECHNICAL SPECIFICATIONS .....</b>	<b>19</b>

# ***Glossary of Acronyms, Terms, and Abbreviations***

**ABC** – Approved Budget for the Contract.

**BAC** – Bids and Awards Committee.

**Bid** – A signed offer or proposal to undertake a contract submitted by a bidder in response to and in consonance with the requirements of the bidding documents. Also referred to as *Proposal* and *Tender*. (2016 revised IRR, Section 5[c])

**Bidder** – Refers to a contractor, manufacturer, supplier, distributor and/or consultant who submits a bid in response to the requirements of the Bidding Documents. (2016 revised IRR, Section 5[d])

**Bidding Documents** – The documents issued by the Procuring Entity as the bases for bids, furnishing all information necessary for a prospective bidder to prepare a bid for the Goods, Infrastructure Projects, and/or Consulting Services required by the Procuring Entity. (2016 revised IRR, Section 5[e])

**BIR** – Bureau of Internal Revenue.

**BSP** – Bangko Sentral ng Pilipinas.

**Consulting Services** – Refer to services for Infrastructure Projects and other types of projects or activities of the GOP requiring adequate external technical and professional expertise that are beyond the capability and/or capacity of the GOP to undertake such as, but not limited to: (i) advisory and review services; (ii) pre-investment or feasibility studies; (iii) design; (iv) construction supervision; (v) management and related services; and (vi) other technical services or special studies. (2016 revised IRR, Section 5[i])

**CDA** - Cooperative Development Authority.

**Contract** – Refers to the agreement entered into between the Procuring Entity and the Supplier or Manufacturer or Distributor or Service Provider for procurement of Goods and Services; Contractor for Procurement of Infrastructure Projects; or Consultant or Consulting Firm for Procurement of Consulting Services; as the case may be, as recorded in the Contract Form signed by the parties, including all attachments and appendices thereto and all documents incorporated by reference therein.

**CIF** – Cost Insurance and Freight.

**CIP** – Carriage and Insurance Paid.

**CPI** – Consumer Price Index.

**DDP** – Refers to the quoted price of the Goods, which means “delivered duty paid.”

**DTI** – Department of Trade and Industry.

**EXW** – Ex works.

**FCA** – “Free Carrier” shipping point.

**FOB** – “Free on Board” shipping point.

**Foreign-funded Procurement or Foreign-Assisted Project**– Refers to procurement whose funding source is from a foreign government, foreign or international financing institution as specified in the Treaty or International or Executive Agreement. (2016 revised IRR, Section 5[b]).

**Framework Agreement** – Refers to a written agreement between a procuring entity and a supplier or service provider that identifies the terms and conditions, under which specific purchases, otherwise known as “Call-Offs,” are made for the duration of the agreement. It is in the nature of an option contract

between the procuring entity and the bidder(s) granting the procuring entity the option to either place an order for any of the goods or services identified in the Framework Agreement List or not buy at all, within a minimum period of one (1) year to a maximum period of three (3) years. (GPPB Resolution No. 27-2019)

**GFI** – Government Financial Institution.

**GOCC** – Government-owned and/or –controlled corporation.

**Goods** – Refer to all items, supplies, materials and general support services, except Consulting Services and Infrastructure Projects, which may be needed in the transaction of public businesses or in the pursuit of any government undertaking, project or activity, whether in the nature of equipment, furniture, stationery, materials for construction, or personal property of any kind, including non-personal or contractual services such as the repair and maintenance of equipment and furniture, as well as trucking, hauling, janitorial, security, and related or analogous services, as well as procurement of materials and supplies provided by the Procuring Entity for such services. The term “related” or “analogous services” shall include, but is not limited to, lease or purchase of office space, media advertisements, health maintenance services, and other services essential to the operation of the Procuring Entity. (2016 revised IRR, Section 5[r])

**GOP** – Government of the Philippines.

**GPPB** – Government Procurement Policy Board.

**INCOTERMS** – International Commercial Terms.

**Infrastructure Projects** – Include the construction, improvement, rehabilitation, demolition, repair, restoration or maintenance of roads and bridges, railways, airports, seaports, communication facilities, civil works components of information technology projects, irrigation, flood control and drainage, water supply, sanitation, sewerage and solid waste management systems, shore protection, energy/power and electrification facilities, national buildings, school buildings, hospital buildings, and other related construction projects of the government. Also referred to as *civil works or works*. (2016 revised IRR, Section 5[u])

**LGUs** – Local Government Units.

**NFCC** – Net Financial Contracting Capacity.

**NGA** – National Government Agency.

**PhilGEPS** - Philippine Government Electronic Procurement System.

**Procurement Project** – refers to a specific or identified procurement covering goods, infrastructure project or consulting services. A Procurement Project shall be described, detailed, and scheduled in the Project Procurement Management Plan prepared by the agency which shall be consolidated in the procuring entity's Annual Procurement Plan. (GPPB Circular No. 06-2019 dated 17 July 2019)

**PSA** – Philippine Statistics Authority.

**SEC** – Securities and Exchange Commission.

**SLCC** – Single Largest Completed Contract.

**Supplier** – refers to a citizen, or any corporate body or commercial company duly organized and registered under the laws where it is established, habitually established in business and engaged in the manufacture or sale of the merchandise or performance of the general services covered by his bid. (Item 3.8 of GPPB Resolution No. 13-2019, dated 23 May 2019). Supplier as used in these Bidding Documents may likewise refer to a distributor, manufacturer, contractor, or consultant.

**UN** – United Nations.

## Section I. Invitation to Bid

# INVITATION TO BID FOR THE HIRING OF OFFICIAL BOOTH AND VENUE ENHANCEMENTS CONTRACTOR FOR MANILA FAME 2024



1. The *Center for International Trade Expositions and Missions (CITEM)*, through the *Manila FAME 2024 Budget* intends to apply the sum of **One Million Three Hundred Thousand Pesos (PhP1,300,000.00)** being the ABC to payments under the contract ***Hiring of Official Booth and Venue Enhancement Contractor for Manila FAME 2024***. Bids received in excess of the ABC shall be automatically rejected at bid opening.
2. The *Center for International Trade Expositions and Missions (CITEM)* now invites bids for the above Procurement Project. Delivery of the Goods is required by **October 17-19, 2024**. Bidders should have completed, within **five (5) years** of the date of submission and receipt of bids, a contract similar to the Project. The description of an eligible bidder is contained in the Bidding Documents, particularly, in Section II (Instructions to Bidders).
3. Bidding will be conducted through open competitive bidding procedures using a non-discretionary “*pass/fail*” criterion as specified in the 2016 revised Implementing Rules and Regulations (IRR) of Republic Act (RA) No. 9184.

Bidding is restricted to Filipino citizens/sole proprietorships, partnerships, or organizations with at least sixty percent (60%) interest or outstanding capital stock belonging to citizens of the Philippines, and to citizens or organizations of a country the laws or regulations of which grant similar rights or privileges to Filipino citizens, pursuant to RA No. 5183.

4. Prospective Bidders may obtain further information from the *Center for International Trade Expositions and Missions (CITEM)* and inspect the Bidding Documents at the address given below during **Mondays to Fridays, 8:00AM - 5:00PM**.
5. A complete set of Bidding Documents may be acquired by interested Bidders on **02 August 2024** from the given address and website(s) below upon payment of the applicable fee for the Bidding Documents, pursuant to the latest Guidelines issued by the GPPB, in the amount of **One Thousand Pesos (Php1,000.00)**. The Procuring Entity shall allow the bidder to present its proof of payment for the fees *through electronic means. Payment shall be made thru CITEM Bank Account below, a copy of bank deposit slip should be emailed to the BAC Secretariat:*

- Bank : Landbank of the Philippines
- Account Name : CITEM
- Account Number : 1772 1038 63
- Bank Address : LBP Century Park (Harrison Plaza) Branch
- Swift Code : TLBPPHMM

6. The **Center for International Trade Expositions and Mission (CITEM)** will hold a Pre-Bid Conference on **13 August 2024, 2:00PM via Zoom** which shall be open to prospective bidders. Please set your Zoom name into this format: Name Surname\_Company Name. Below is the access the conference:  
<https://zoom.us/j/8549547139>  
**ID** 854 954 7139
7. Bids must be duly received by the BAC Secretariat through manual submission at the office address indicated below on or before **27 August 2024, 2:00PM**. **Late bids shall not be accepted.**
8. All Bids must be accompanied by a bid security in any of the acceptable forms and in the amount stated in **ITB Clause 14**.

9. Bid opening shall be on **27 August 2024, 2:00PM via Zoom**. Bids will be opened in the presence of the bidders' representatives who choose to attend the activity. Please set your Zoom name into this format: Name Surname\_Company Name. Below is the access the conference:  
 <https://zoom.us/j/8549547139>  
 854 954 7139
10. Bidders may access the prescribed forms and sample formats in this link: <https://tinyurl.com/53te6sky>
11. The **Center for International Trade Expositions and Mission (CITEM)** reserves the right to reject any and all bids, declare a failure of bidding, or not award the contract at any time prior to contract award in accordance with Sections 35.6 and 41 of the 2016 revised IRR of RA No. 9184, without thereby incurring any liability to the affected bidder or bidders.
12. For further information, please refer to:

**CITEM-BAC Secretariat**

Center for International Trade Expositions and Missions  
Golden Shell Pavilion  
Roxas Blvd. Cor. Sen. Gil Puyat Ave., Pasay City  
Tel no. +63(2) 8-831-2201 loc. 294/309  
Email: [citembac@citem.com.ph](mailto:citembac@citem.com.ph)  
Website: [www.citem.com.ph](http://www.citem.com.ph)

13. You may visit the following websites:

For downloading of Bidding Documents: <https://citem.gov.ph/procurement/invitation-to-bid>

**02 August 2024**



---

**ATTY. ANNA GRACE I. MARPURI**  
*Chairman, CITEM-Bids and Awards Committee*

## **Section II. Instructions to Bidders**

### **1. Scope of Bid**

The Procuring Entity, *Center for International Trade Expositions and Missions (CITEM)* wishes to receive Bids for the **Official Booth and Venue Enhancement Contractor MANILA FAME 2024**, with identification number **CITEM-2024-0118-R1**.

The Procurement Project (referred to herein as "Project") is composed of *one lot*, the details of which are described in Section VII (Technical Specifications).

### **2. Funding Information**

2.1. The GOP through the source of funding as indicated below for FY 2024 in the amount of **One Million Three Hundred Thousand Pesos (PhP1,300,000.00)**.

2.2. The source of funding is GOCC, the Corporate Operating Budget.

### **3. Bidding Requirements**

The Bidding for the Project shall be governed by all the provisions of RA No. 9184 and its 2016 revised IRR, including its Generic Procurement Manuals and associated policies, rules and regulations as the primary source thereof, while the herein clauses shall serve as the secondary source thereof.

Any amendments made to the IRR and other GPPB issuances shall be applicable only to the ongoing posting, advertisement, or **IB** by the BAC through the issuance of a supplemental or bid bulletin.

The Bidder, by the act of submitting its Bid, shall be deemed to have verified and accepted the general requirements of this Project, including other factors that may affect the cost, duration and execution or implementation of the contract, project, or work and examine all instructions, forms, terms, and project requirements in the Bidding Documents.

### **4. Corrupt, Fraudulent, Collusive, and Coercive Practices**

The Procuring Entity, as well as the Bidders and Suppliers, shall observe the highest standard of ethics during the procurement and execution of the contract. They or through an agent shall not engage in corrupt, fraudulent, collusive, coercive, and obstructive practices defined under Annex "I" of the 2016 revised IRR of RA No. 9184 or other integrity violations in competing for the Project.

### **5. Eligible Bidders**

5.1. Only Bids of Bidders found to be legally, technically, and financially capable will be evaluated.

5.2. Foreign ownership limited to those allowed under the rules may participate in this Project.

5.3. Pursuant to Section 23.4.1.3 of the 2016 revised IRR of RA No.9184, the Bidder shall have an SLCC that is at least one (1) contract similar to the Project the value of which, adjusted to current prices using the PSA's CPI, must be at least equivalent to:

For the procurement of Non-expendable Supplies and Services: The Bidder must have completed a single contract that is similar to this Project, equivalent to at least fifty percent (50%) of the ABC.

5.4. The Bidders shall comply with the eligibility criteria under Section 23.4.1 of the 2016 IRR of RA No. 9184.

### **6. Origin of Goods**

There is no restriction on the origin of goods other than those prohibited by a decision of the UN Security Council taken under Chapter VII of the Charter of the UN, subject to Domestic Preference requirements under **ITB** Clause 18.

## 7. Subcontracts

- 7.1. ***The Procuring Entity has prescribed that Subcontracting is not allowed.***
- 7.2. The Supplier may identify its subcontractor during the contract implementation stage. Subcontractors identified during the bidding may be changed during the implementation of this Contract. Subcontractors must submit the documentary requirements under Section 23.1 of the 2016 revised IRR of RA No. 9184 and comply with the eligibility criteria specified in **ITB** Clause 5 to the implementing or end-user unit.
- 7.3. Subcontracting of any portion of the Project does not relieve the Supplier of any liability or obligation under the Contract. The Supplier will be responsible for the acts, defaults, and negligence of any subcontractor, its agents, servants, or workmen as fully as if these were the Supplier's own acts, defaults, or negligence, or those of its agents, servants, or workmen.

## 8. Pre-Bid Conference

The Procuring Entity will hold a pre-bid conference for this Project on the specified date and time via Zoom as indicated in paragraph 6 of the **IB**.

## 9. Clarification and Amendment of Bidding Documents

Prospective bidders may request for clarification on and/or interpretation of any part of the Bidding Documents. Such requests must be in writing and received by the Procuring Entity, either at its given address or through electronic mail indicated in the **IB**, at least ten (10) calendar days before the deadline set for the submission and receipt of Bids.

## 10. Documents comprising the Bid: Eligibility and Technical Components

- 10.1. The first envelope shall contain the eligibility and technical documents of the Bid as specified in **Section VIII (Checklist of Technical and Financial Documents)**.
- 10.2. The Bidder's SLCC as indicated in **ITB** Clause 5.3 should have been completed within **five (5) years** prior to the deadline for the submission and receipt of bids.
- 10.3. If the eligibility requirements or statements, the bids, and all other documents for submission to the BAC are in foreign language other than English, it must be accompanied by a translation in English, which shall be authenticated by the appropriate Philippine foreign service establishment, post, or the equivalent office having jurisdiction over the foreign bidder's affairs in the Philippines. Similar to the required authentication above, for Contracting Parties to the Apostille Convention, only the translated documents shall be authenticated through an apostille pursuant to GPPB Resolution No. 13-2019 dated 23 May 2019. The English translation shall govern, for purposes of interpretation of the bid.

## 11. Documents comprising the Bid: Financial Component

- 11.1. The second bid envelope shall contain the financial documents for the Bid as specified in **Section VIII (Checklist of Technical and Financial Documents)**.
- 11.2. If the Bidder claims preference as a Domestic Bidder or Domestic Entity, a certification issued by DTI shall be provided by the Bidder in accordance with Section 43.1.3 of the 2016 revised IRR of RA No. 9184.
- 11.3. Any bid exceeding the ABC indicated in paragraph 1 of the **IB** shall not be accepted.
- 11.4. For Foreign-funded Procurement, a ceiling may be applied to bid prices provided the conditions are met under Section 31.2 of the 2016 revised IRR of RA No. 9184.

## 12. Bid Prices

- 12.1. Prices indicated on the Price Schedule shall be entered separately in the following manner:
  - a. For Goods offered from within the Procuring Entity's country:



- i. The price of the Goods quoted EXW (ex-works, ex-factory, ex-warehouse, ex-showroom, or off-the-shelf, as applicable);
  - ii. The cost of all customs duties and sales and other taxes already paid or payable;
  - iii. The cost of transportation, insurance, and other costs incidental to delivery of the Goods to their final destination; and
  - iv. The price of other (incidental) services, if any, listed in the **BDS**.
- b. For Goods offered from abroad:
  - i. Unless otherwise stated in the **BDS**, the price of the Goods shall be quoted delivered duty paid (DDP) with the place of destination in the Philippines as specified in the **BDS**. In quoting the price, the Bidder shall be free to use transportation through carriers registered in any eligible country. Similarly, the Bidder may obtain insurance services from any eligible source country.
  - ii. The price of other (incidental) services, if any, as listed in the **BDS**.

**13. Bid and Payment Currencies**

- 13.1. For Goods that the Bidder will supply from outside the Philippines, the bid prices may be quoted in the local currency or tradeable currency accepted by the BSP at the discretion of the Bidder. However, for purposes of bid evaluation, Bids denominated in foreign currencies, shall be converted to Philippine currency based on the exchange rate as published in the BSP reference rate bulletin on the day of the bid opening.
- 13.2. Payment of the contract price shall be made in Philippine Pesos.

**14. Bid Security**

- 14.1. The Bidder shall submit a Bid Securing Declaration or any form of Bid Security in the amount indicated in the **BDS**, which shall be not less than the percentage of the ABC in accordance with the schedule in the **BDS**.
- 14.2. The Bid and bid security shall be valid until **120 calendar days upon opening of bids**. Any Bid not accompanied by an acceptable bid security shall be rejected by the Procuring Entity as non-responsive.

**15. Sealing and Marking of Bids**

Each Bidder shall submit one copy of the first and second components of its Bid.

The Procuring Entity may request additional hard copies and/or electronic copies of the Bid. However, failure of the Bidders to comply with the said request shall not be a ground for disqualification.

If the Procuring Entity allows the submission of bids through online submission or any other electronic means, the Bidder shall submit an electronic copy of its Bid, which must be digitally signed. An electronic copy that cannot be opened or is corrupted shall be considered non-responsive and, thus, automatically disqualified.

**16. Deadline for Submission of Bids**

The Bidders shall submit on the specified date and time and either at its physical address or through online submission as indicated in paragraph 7 of the **IB**.

**17. Opening and Preliminary Examination of Bids**

- 17.1. The BAC shall open the Bids in public at the time, on the date, and at the place specified in paragraph 9 of the **IB**. The Bidders' representatives who are present shall sign a register evidencing their attendance. In case videoconferencing, webcasting or other

similar technologies will be used, attendance of participants shall likewise be recorded by the BAC Secretariat.

In case the Bids cannot be opened as scheduled due to justifiable reasons, the rescheduling requirements under Section 29 of the 2016 revised IRR of RA No. 9184 shall prevail.

17.2. The preliminary examination of bids shall be governed by Section 30 of the 2016 revised IRR of RA No. 9184.

**18. Domestic Preference**

The Procuring Entity will grant a margin of preference for the purpose of comparison of Bids in accordance with Section 43.1.2 of the 2016 revised IRR of RA No. 9184.

**19. Detailed Evaluation and Comparison of Bids**

19.1. The Procuring Entity's BAC shall immediately conduct a detailed evaluation of all Bids rated "*passed*," using non-discretionary pass/fail criteria. The BAC shall consider the conditions in the evaluation of Bids under Section 32.2 of the 2016 revised IRR of RA No. 9184.

19.2. If the Project allows partial bids, bidders may submit a proposal on any of the lots or items, and evaluation will be undertaken on a per lot or item basis, as the case maybe. In this case, the Bid Security as required by **ITB** Clause 14 shall be submitted for each lot or item separately.

19.3. The descriptions of the lots or items shall be indicated in **Section VII (Technical Specifications)**, although the ABCs of these lots or items are indicated in the **BDS** for purposes of the NFCC computation pursuant to Section 23.4.2.6 of the 2016 revised IRR of RA No. 9184. The NFCC must be sufficient for the total of the ABCs for all the lots or items participated in by the prospective Bidder.

19.4. The Project shall be awarded as One Project having several items that shall be awarded as one contract.

19.5. Except for bidders submitting a committed Line of Credit from a Universal or Commercial Bank in lieu of its NFCC computation, all Bids must include the NFCC computation pursuant to Section 23.4.1.4 of the 2016 revised IRR of RA No. 9184, which must be sufficient for the total of the ABCs for all the lots or items participated in by the prospective Bidder. For bidders submitting the committed Line of Credit, it must be at least equal to ten percent (10%) of the ABCs for all the lots or items participated in by the prospective Bidder.

**20. Post-Qualification**

20.1. Within a non-extendible period of five (5) calendar days from receipt by the Bidder of the notice from the BAC that it submitted the Lowest Calculated Bid, the Bidder shall submit its latest income and business tax returns filed and paid through the BIR Electronic Filing and Payment System (eFPS) and other appropriate licenses and permits required by law and stated in the **BDS**.

**21. Signing of the Contract**

21.1. The documents required in Section 37.2 of the 2016 revised IRR of RA No. 9184 shall form part of the Contract. Additional Contract documents are indicated in the **BDS**.

### Section III. Bid Data Sheet

ITB Clause	
5.3	<p>For this purpose, contracts similar to the Project shall be:</p> <ul style="list-style-type: none"> <li>a. Supply, Delivery, and Installation and Dismantling of Aluminum Booth System and other Exhibit</li> <li>b. Completed <b>within five (5) years</b> prior to the deadline for the submission and receipt of bids.</li> </ul>
7.1	<i>Subcontracting is not allowed</i>
10	<p>Statement of the Bidder's SLCC similar to the contract to be bid shall contain the following:</p> <ul style="list-style-type: none"> <li>i. Name of the completed contract with contract date, period and amount, which should correspond to the required percentage of the ABC to be bid. The value is adjusted to the current prices using the Philippine Statistics Authority consumer price indices, when necessary;</li> <li>ii. The relevant period or delivery date when the said SLCC was completed; end user's acceptance or official receipt(s) or sales invoice issued for the contract, and;</li> <li>iii. Definition or description of the similar project or major categories of work.</li> </ul> <p>Statement of the Bidder of all its ongoing government and private contracts, including contracts awarded but not yet started shall contain the following:</p> <ul style="list-style-type: none"> <li>i. Names of outstanding contracts with other contracting party, i.e., Procuring Entity or private company allowed by the rules, contract date, period and amount or value; and</li> <li>ii. Kinds of Goods and dates of delivery.</li> </ul>
12	<p>The price of the Goods shall be quoted DDP of the venue of the event or the applicable International Commercial Terms (INCOTERMS) for this Project.</p> <p>Possibility of on-site orders of items or services. Bidders are required to attach its "Price list" of items and services. Bidders may add items on top of the listed items and/or services.</p> <p><b>FURNITURE, FIXTURES, &amp; CARPET</b>  Stacking Chair  Monobloc Chair  White Folding Chair  Bar Stool White  Visitor Chairs with Back rest  Info Table  System Table Lockable  Round Black Laminated Table (60cm dia.)  Round Glass Table (90cm dia.) - Cross Legs  Cocktail Laminated Table  Flat Shelves  Brochure Rack  Trash Bin  Needle Punch Carpet  TV Stand  Showcase (.5 x 1m x 2m)  Showcase (.5 x .5m x 2m)  Showcase (.5 x 1m x 1m)  Flush Door  Coat Stand</p> <p><b>ADDITIONAL PANELS</b>  White Panel 1m (w) x 2.5 (h)</p>

Clear Acrylic Panel 1m (w) x 2.5 (h) x 3mm thick  
Colored Panel (1m x 2.5m x 3mm) - 1 side sticker  
Colored Panel (1m x 2.5m x 3mm) - 2 sides sticker  
Standard White Panel w/ System Frame  
White painted wooden panel (1m x 2.4m x 18mm)

**ELECTRICAL FACILITIES**

Fluorescent Lamp (40w)  
Long-arm Spotlight LED 12w  
Short-arm Spotlight LED 12w  
Floodlights Halogen (150-300w)  
Floodlights Halogen (500w)  
Floodlights Metal Halide (150-300w)  
Floodlights Metal Halide (500w)  
Convenience Outlet 3gang(300w)  
Adaptor  
Outdoor Lighting Requirement

**CIRCUIT BREAKER SINGLE PHASE**

4.4 Kw with 20 Amp 220V 60 Hz Circuit Breaker  
6.6 Kw with 30 Amp 220V 60 Hz Circuit Breaker  
13.2 Kw with 60 Amp 220V 60 Hz Circuit Breaker

**CIRCUIT BREAKER THREE PHASE**

6.6 Kw with 30 Amp 220V 60 Hz Circuit Breaker  
13.2 Kw with 60 Amp 220V 60 Hz Circuit Breaker

**DAILY RENTAL FACILITIES**

43" LED TV w/ USB, VGA, HDMI  
55" LED TV w/ USB, VGA, HDMI  
Retractable Stanchion  
Scaffolding

**OTHER FACILITIES**

6 CU. Ft. Refrigerator  
Bar Refrigerator  
Coffee Maker  
Water Dispenser w/ 5gals water supply  
Platform 4ft. x 8 ft. x 4inch thick  
Water Line with sink (*required approval from organizer*)  
Water Line without sink (*required approval from organizer*)  
Stage and Rigging  
RGB Spotlight  
Automatic Hand Sanitizer  
Temperature-Measurement & Hand Sanitizer Kiosk  
Foot Press Alcohol Hand Sanitizer Dispenser  
Hand Sanitizer – Face Mask – tissue Dispenser Kiosk  
Sneeze Guard Protection Shield  
Automatic Footwear Sanitizer  
Basic Sanitation Tunnel  
9sqm Carpet with Convenience Outlet 3gang(300w) and 3 Spotlight  
9sqm Carpet with Convenience Outlet 3gang(300w)  
Scaffolding

**MANPOWER (VENUE)**

System Assembler  
Graphics Artist  
Carpenter  
Painter  
Electrician  
Utility / Mover

14.1	<p>The bid security shall be in the form of a Bid Securing Declaration, or any of the following forms and amounts:</p> <ul style="list-style-type: none"> <li>a. The amount of not less than <b>Twenty-Six Thousand Pesos (Php26,000.00)</b>, if bid security is in cash, cashier's/manager's check, bank draft/guarantee or irrevocable letter of credit; or</li> <li>b. The amount of not less than <b>Sixty-Five Thousand Pesos (Php65,000.00)</b> if bid security is in Surety Bond.</li> </ul>
19.3	<i>The project is being bid as a Single Lot.</i>
20.1	Accreditation in the form of Enrollment form/ Official Receipt/ or any document confirming accreditation from <b>World Trade Center, Metro Manila, Philippines</b>
21.2	<i>No additional requirement.</i>

## **Section IV. General Conditions of Contract**

### **1. Scope of Contract**

This Contract shall include all such items, although not specifically mentioned, that can be reasonably inferred as being required for its completion as if such items were expressly mentioned herein. All the provisions of RA No. 9184 and its 2016 revised IRR, including the Generic Procurement Manual, and associated issuances, constitute the primary source for the terms and conditions of the Contract, and thus, applicable in contract implementation. Herein clauses shall serve as the secondary source for the terms and conditions of the Contract.

This is without prejudice to Sections 74.1 and 74.2 of the 2016 revised IRR of RA No. 9184 allowing the GPPB to amend the IRR, which shall be applied to all procurement activities, the advertisement, posting, or invitation of which were issued after the effectivity of the said amendment.

Additional requirements for the completion of this Contract shall be provided in the **Special Conditions of Contract (SCC)**.

### **2. Advance Payment and Terms of Payment**

2.1. Advance payment of the contract amount is provided under Annex "D" of the revised 2016 IRR of RA No. 9184.

2.2. The Procuring Entity is allowed to determine the terms of payment on the partial or staggered delivery of the Goods procured, provided such partial payment shall correspond to the value of the goods delivered and accepted in accordance with prevailing accounting and auditing rules and regulations. The terms of payment are indicated in the **SCC**.

### **3. Performance Security**

Within ten (10) calendar days from receipt of the Notice of Award by the Bidder from the Procuring Entity but in no case later than the signing of the Contract by both parties, the successful Bidder shall furnish the performance security in any of the forms prescribed in Section 39 of the 2016 revised IRR of RA No. 9184.

### **4. Inspection and Tests**

The Procuring Entity or its representative shall have the right to inspect and/or to test the Goods to confirm their conformity to the Project specifications at no extra cost to the Procuring Entity in accordance with the Generic Procurement Manual. In addition to tests in the **SCC, Section VII (Technical Specifications)** shall specify what inspections and/or tests the Procuring Entity requires, and where they are to be conducted. The Procuring Entity shall notify the Supplier in writing, in a timely manner, of the identity of any representatives retained for these purposes.

All reasonable facilities and assistance for the inspection and testing of Goods, including access to drawings and production data, shall be provided by the Supplier to the authorized inspectors at no charge to the Procuring Entity.

### **5. Warranty**

5.1 In order to assure that manufacturing defects shall be corrected by the Supplier, a warranty shall be required from the Supplier as provided under Section 62.1 of the 2016 revised IRR of RA No. 9184.

5.2 The Procuring Entity shall promptly notify the Supplier in writing of any claims arising under this warranty. Upon receipt of such notice, the Supplier shall, repair or replace the defective Goods or parts thereof without cost to the Procuring Entity, pursuant to the Generic Procurement Manual.

**6. Liability of the Supplier**

The Supplier's liability under this Contract shall be as provided by the laws of the Republic of the Philippines.

If the Supplier is a joint venture, all partners to the joint venture shall be jointly and severally liable to the Procuring Entity

## **Section V. Special Conditions of Contract**

<b>GCC Clause</b>	
1	<p><b>Delivery and Documents –</b></p> <p>For purposes of the Contract, “EXW,” “FOB,” “FCA,” “CIF,” “CIP,” “DDP” and other trade terms used to describe the obligations of the parties shall have the meanings assigned to them by the current edition of INCOTERMS published by the International Chamber of Commerce, Paris. The Delivery terms of this Contract shall be as follows:</p> <p>“The delivery terms applicable to this Contract are delivered to the <i>World Trade Center Metro Manila</i>. Risk and title will pass from the Supplier to the Procuring Entity upon receipt and final acceptance of the Goods at their final destination.”</p> <p>Delivery of the Goods shall be made by the Supplier in accordance with the terms specified in Section VI (Schedule of Requirements).</p> <p>For purposes of this Clause the Procuring Entity’s Representative at the Project Site is <i>Norman D. Bagulbagul and Katherine May G. Apodaca</i>.</p> <p><b>Incidental Services –</b></p> <p>The Supplier is required to provide all of the following services, including additional services, if any, specified in Section VI. Schedule of Requirements:</p> <ol style="list-style-type: none"> <li>a. performance or supervision of on-site assembly and/or start-up of the supplied Goods;</li> <li>b. furnishing of tools required for assembly and/or maintenance of the supplied Goods;</li> <li>c. performance or supervision or maintenance and/or repair of the supplied Goods, for a period of time agreed by the parties, provided that this service shall not relieve the Supplier of any warranty obligations under this Contract; and</li> <li>d. Provision of requirements based on list of amenities and/or menu of services from the contractor as required by CITEM. (See list of amenities at Annex C)</li> </ol>
	<p>The Contract price for the Goods shall include the prices charged by the Supplier for incidental services and shall not exceed the prevailing rates charged to other parties by the Supplier for similar services.</p> <p><b>Transportation –</b></p> <p>Where the Supplier is required under Contract to deliver the Goods CIF, CIP, or DDP, transport of the Goods to the port of destination or such other named place of destination in the Philippines, as shall be specified in this Contract, shall be arranged and paid for by the Supplier, and the cost thereof shall be included in the Contract Price.</p> <p>Where the Supplier is required under this Contract to transport the Goods to a specified place of destination within the Philippines, defined as the Project Site, transport to such place of destination in the Philippines, including insurance and storage, as shall be specified in this Contract, shall be arranged by the Supplier, and related costs shall be included in the contract price.</p>
	<p>Where the Supplier is required under Contract to deliver the Goods CIF, CIP or DDP, Goods are to be transported on carriers of Philippine registry. In the event that no carrier of Philippine registry is available, Goods may be shipped by a carrier which is not of Philippine registry provided that the Supplier obtains and presents to the Procuring Entity certification to this effect from the nearest Philippine consulate to the port of dispatch. In the event that carriers of Philippine registry are available but their schedule delays the Supplier in its performance of this Contract the period from when the Goods were first ready for shipment and the actual date of shipment the period of delay will be considered force majeure.</p>



	<p>The Procuring Entity accepts no liability for the damage of Goods during transit other than those prescribed by INCOTERMS for DDP deliveries. In the case of Goods supplied from within the Philippines or supplied by domestic Suppliers risk and title will not be deemed to have passed to the Procuring Entity until their receipt and final acceptance at the final destination.</p> <p><b>Intellectual Property Rights –</b></p> <p>The Supplier shall indemnify the Procuring Entity against all third-party claims of infringement of patent, trademark, or industrial design rights arising from use of the Goods or any part thereof.</p>
2.2	<p>The total amount to be paid by CITEM shall be based on the following conditions:</p> <p>The final order or actual number of <b>ALUMINUM SYSTEM BOOTHS 3x3</b> to be installed or the total number in sq.m during ingress, as verified by CITEM's Experience Design Division (EDD) and Inspection Team representatives;</p> <p><b>Venue enhancements, Logistics and Incidental Requirements</b> shall be based on the awarded cost and actual quantity as verified by the Experience Design Division (EDD) and Inspection Team representatives.</p>
4	<p>The inspections and tests that will be conducted are Quantity and Quality Testing.</p>

## **Section VI. Schedule of Requirements**

The delivery schedule expressed as weeks/months stipulates hereafter a delivery date which is the date of delivery to the project site.

	<b>PROJECT COMPONENTS</b>	<b>SCHEDULE OF TURNOVER TO CITEM</b>
a.	Booth Plotting	Start of ingress until 10:00 am on 1 <sup>st</sup> day of Ingress / October 14, 2024
b.	Special Area Carpet Requirements	Start of ingress until 12:00 nn on 1 <sup>st</sup> day of Ingress / October 14, 2024
c.	Special Areas Electrical and Power Supply	Start of ingress until 12:00 nn on 1 <sup>st</sup> day of Ingress/ October 14, 2024
d.	Registration Counter and Ingress counter with Electricals	Start of ingress until 12:00nn on 1 <sup>st</sup> day of Ingress / October 14, 2024
e.	Aluminum-based Requirements and Collateral	Start of ingress until 8:00 p.m. on 2 <sup>nd</sup> day of Ingress / October 15, 2024
f.	Exhibitor Booth Package	Start of ingress until 12:00 p.m. on 2 <sup>nd</sup> day of Ingress / October 15, 2024
g.	Maintenance Support During Event	Start of Event Proper October 17, 2024 to October 19, 2024
h.	Egress Clearance	03:00pm of October 19, 2024 onwards
i.	Egress Proper	07:00pm of October 19, 2024 until 12:00am

I hereby commit to comply and deliver all the above requirement in accordance with the above stated schedule.

\_\_\_\_\_  
**Name of Company/Bidder**  
 Date

(Signature Over Printed Name)  
**Bidder/Authorized Representative**



**STANDARD AMENITIES**

- 9 sq.m. Dark Gray / Black carpet
- 1 lot Structural Frame
- 1 lot Fascia and Fins
- 2 units Chair
- 1 unit Negotiation Table
- 3 units Shelving
- 3 units Light bulb with housing and wiring
- 1 unit 3 gang convenience outlet (300 watts)
- 1 unit Trash Bin

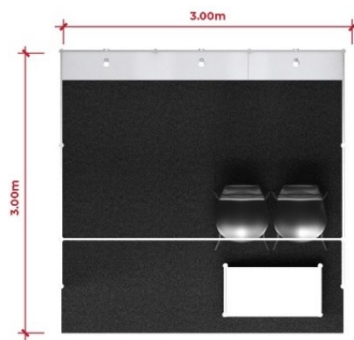

**TOP VIEW**

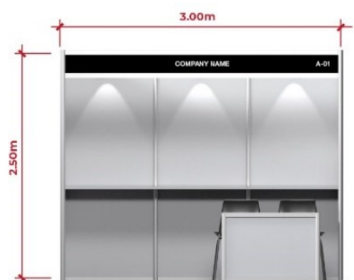

**FRONT ELEVATION**

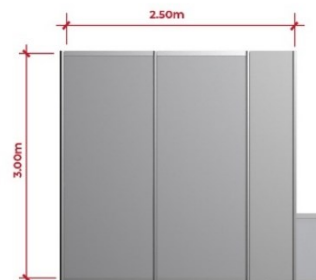

**SIDE ELEVATION**

## Section VII. Technical Specifications

*Bidders must state here either "Comply" or "Not Comply" against each of the individual parameters of each Specification stating the corresponding performance parameter of the equipment offered. Statements of "Comply" or "Not Comply" must be supported by evidence in a Bidders Bid and cross-referenced to that evidence. Evidence shall be in the form of manufacturer's un-amended sales literature, unconditional statements of specification and compliance issued by the manufacturer, samples, independent test data etc., as appropriate. A statement that is not supported by evidence or is subsequently found to be contradicted by the evidence presented will render the Bid under evaluation liable for rejection. A statement either in the Bidder's statement of compliance or the supporting evidence that is found to be false either during Bid evaluation, post-qualification or the execution of the Contract may be regarded as fraudulent and render the Bidder or supplier liable for prosecution subject to the applicable laws and issuances*

Item	Specification	Statement of Compliance
<b>1. METHOD OF QUOTATION</b>		
1.1	The qualified bidder shall submit their proposal for the <b>Standard Aluminum Booth System 3x3</b> on a per square meter basis which should <b>NOT</b> exceed the rate of <b>Php900/sq.m</b> inclusive of all applicable government taxes;	
1.2	The qualified bidder shall submit their <u>ALL-IN proposal</u> for the Venue Enhancements, Logistics and Incidental Requirements provided they have complied with the conditions set forth in Sec. VII Items 1.1 and <b>should not exceed the projected budget ceiling for the Venue Enhancements, Logistics and Incidental Requirements.</b>	
1.3	For item 1.1, the bidder should submit the proposed rate per sqm. multiplied by <b>105 units</b> (projected no. of booths) in the bid form.	
1.4	That the total quotation of the bidder shall not exceed the approved budget.	
<b>2. CONDITIONS FOR PAYMENT</b>		
	The total amount to be paid by CITEM shall be based on the following conditions:	
2.1	The final order or actual number of <b>STANDARD ALUMINUM BOOTH SYSTEM 3x3</b> to be installed or the total number in sq.m during the second day of ingress, as verified by CITEM's Experience Design Division (EDD) and Inspection Team representatives;	
2.2	<b>Venue enhancements, Logistics and Incidental Requirements</b> shall be based on the awarded cost and actual quantity as verified by the Experience Design Division (EDD) and Inspection Team representatives;	
<b>3. PENALTY</b>		
3.1	In case of breach or failure to comply with the timeline stated in the Project Turnover Schedule a deduction shall be imposed equivalent to one percent (1%) of the total contract price for <b>every hour of delay.</b>	
3.2	Likewise, in case of poor or substandard quality of work and deviation from specifications, a deduction shall be imposed equivalent to 10% of the amount of the event component.	
3.3	Once the cumulative amount of liquidated damages reaches 10% of the amount of the contract, the procuring entity shall rescind the contract without prejudice to other course of action and remedies open to it.	
<b>4. SCOPE OF WORK</b>		
The Official booth and venue Contractor shall have full responsibility to undertake the following:		
<b><u>4.1 On Booth Requirements and Amenities</u></b>		

4.1.1	Take charge of all booth requirements and amenities of the Organizer and Exhibitors <i>and shall have the over-all supervision and responsibility for the exhibit and activity areas of the fair;</i>	
4.1.2	Provide the Exhibitor booth package for Manila FAME with booth amenities as listed in the attached. All amenities should be of good quality and clean material;	
4.1.3	Provide all pertinent exhibition forms (e.g., Additional Amenities Order Forms, Electrical Plan and Order Forms, Application for Outside Contractors/Subcontractors, etc.) to the Exhibitors except the Booth Order Forms to be provided by the Organizer;	
4.1.4	Act on the accomplished Booth Order Forms to be forwarded by the Organizer;	
4.1.5	Act on all accomplished Additional Amenities Order Forms and Electrical Plan and Order Forms, to be submitted by the Exhibitors and shall bill the Exhibitors directly and collect payment depending on each order accordingly including the electrical consumption for standard booth systems.	
4.1.6	Allow other booth contractors to service the requirements of other Exhibitors only when:  A. The booth to be used by another contractor is substantially different by, at least, 80% from that of the Official Booth Contractor's booth or is not made of materials or derivatives of materials being used by the Official Booth Contractor for its aluminum shell scheme; and  B. The Official Booth Contractor cannot execute the booths required by said Exhibitors.	
4.1.7	Allow exhibitors to tap <u>in-house</u> personnel or affiliate/subsidiary companies including designers/architects, carpenters, and workers to execute and install their own booths since they do not represent a separate company or contractor, as long as these are not made of materials being used by the official booth contractor for its aluminum shell scheme; and	
4.1.8	The Official Contractor must provide, at least, 10% of its stand and materials inventory on site to serve as back-up for the additional on-site requirements.	
<b>4.2 On Venue Enhancements and Requirements</b>		
4.2.1	The Official Contractor shall have the overall responsibility for fabricating, installing, and dismantling of all venue enhancements.	
4.2.2	The Official Contractor shall, likewise, provide incidental venue enhancements such as but not limited to stage or specialty lighting, proprietary materials, and special effects equipment among others.	
4.2.3	The venue enhancements shall include but are not limited to items listed below subject to funds availability:  a. Signage Structure, Paneling, systems-based enhancements, etc. b. Lobby enhancements (plants, props, etc.) as deemed necessary and essential to the show. c. Other enhancements to be agreed upon by both parties within the amount posted.	
4.2.4	The Official Contractor is responsible for monitoring the costs of venue enhancements to ensure that same is within the amount posted.	
4.2.5	Provide panel cover on all booths against the wall to allow Exhibitors to use it as storage. Location to be discussed.	
4.2.6	Provide an Ingress Counter and should be available before 12 noon on the first day of ingress.	
4.2.7	The Official Contractor warrants and shall guarantee all its works, deliverables, and services to be in good condition and in accordance with the best acceptable professional standards and theories of the exhibition industry throughout the duration of the project.	

<b>4.3 On Electrical Requirements</b>		
The Official Contractor shall be designated as the Official Utility Contractor, as well, for both water and electrical requirements with the following deliverables:		
4.3.1	Submit electrical layouts to the venue owner and to CITEM, at least, three (3) days or as required by the venue owner before the scheduled contractors' ingress;	
4.3.2	Coordinate directly with exhibition venue electricians/electrical engineers regarding house electrical regulations prior to tapping. On the other hand, Exhibitors' stand builders must coordinate with the designated official booth system/electrical contractor;	
4.3.3	Be responsible for inspecting all electrical installations and connections;	
4.3.4	Allow the additional electrical connection to be installed by the Exhibitors provided that this has been requested in advance and there is excess power capacity to accommodate it for which the official booth contractor may charge a corresponding fee to be approved by CITEM;	
4.3.5	Ensure that all electrical wiring, circuit breakers, transformers, convenience outlets, etc. used for the booths, registration/information counters, other counters and special settings are installed in accordance with electrical standards and are securely and neatly fastened and kept away from walkways/aisles in public view/access. Further, the material to be used for fastening purposes (e.g., tapes, molding, etc.) should match the color/shade of the background surface;	
4.3.6	Provide electrical connection of 600 watts (300 watts lighting and 300 watts outlet) per 9 square meter booth for Exhibitors availing of the booth systems package. The electrical consumption shall be on a fixed rate per 9 sq.m, 6sq.m and 4sq.m. booth based on the prevailing kilowatt hour of the venue;	
4.3.7	Before egress, the Contractor shall collect the electrical consumption fee from Exhibitors availing of the booth systems package as part of the Egress clearance procedure.	
4.3.8	Exhibitors availing of RAW SPACE with more than 600W electrical load is required to apply for their own circuit breaker with the Official Booth Contractor;	
4.3.9	For exhibitors with electrical consumption exceeding the 600 watts allocation per 9, 6 and 4 square meter booth system package, the Official Contractor shall charge the prevailing kilowatt hour rate + 12 % VAT during ingress and event proper based on exhibitors' actual requirement as indicated in the submitted Electrical Plan and Order Form. These amounts may vary depending on the electrical charges of the event venue per kilowatt hour;	
4.3.10	For raw space Exhibitors, the Official Contractor shall charge the electrical consumption based on submitted Electrical Plan and Order Form. These amounts may vary depending on the electrical charges of the event venue per kilowatt hour and the required load requirement of each exhibitor.	
4.3.11	The Official Contractor shall prepare a summary of electrical consumption to be submitted to CITEM and venue owner.	
4.3.12	Pay the venue owner the total electrical consumption collected from exhibitors who availed of the CITEM booth system and those who applied for individual circuit breakers used during the event <u>except those used by CITEM for special settings and areas and partners.</u>	
<b>4.4 Water Connection Requirements</b>		
4.4.1	The connection to the existing water supply network of the exhibition venue must be directly carried out by the Official Contractor with reference to the water connection requirements of CITEM on behalf of the Exhibitors and participants;	

4.4.2	If the need arises, the Official Contractor shall install a temporary preparation and wash area at a location that will be agreed upon by CITEM and Venue Owner with the following provisions:  a. Sink with faucet b. Preparation table c. Water connection d. Wastewater system e. Enclosed room (system or tent) f. Waste bin	
<b><u>4.5 Manpower Requirements</u></b>		
4.5.1	Assign its own supervisory personnel, technical staff, electricians, booth system and carpet installers, etc. to attend to and service the booth and electrical requirements of the Exhibitors and CITEM from ingress to egress.	
4.5.2	The assigned personnel shall give utmost priority to CITEM projects and shall be sufficient enough in number to cover and finish all requirements on the required time. The performance of these personnel shall be subject to the evaluation by CITEM.	
4.5.3	All assigned personnel must be in proper uniform and must wear an appropriate ID at all times when in the exhibition site. The uniform must indicate if some assigned personnel is an electrician, installer, carpenter, etc.	
4.5.4	Provide and install a service information booth during the ingress to egress to easily locate its personnel for immediate rendering of services.	
4.5.6	Assign enough supervisory personnel, technicians and electricians to attend to and service the booth and electrical requirements of the Exhibitors and CITEM during the ingress and fair proper. Personnel must be present especially right before the opening of the trade fair.	
<b><u>4.6 Other Service Requirements</u></b>		
4.6.1	Take charge of the plotting of the assigned venue prior to the contractors' ingress under the supervision of CITEM's Exhibition Design Division.	
4.6.2	As needed, the OBC shall Install, dismantle and haul new or existing CITEM carpets on agreed time schedule.	
4.6.3	Board up vacant booths and vacant spaces using aluminum systems framing, <b>free of charge</b> . The instruction to board up shall come from the Exhibition Design Division and; provide free of charge system-based amenities. <b>See annex A and annex B</b> for free of charge system-based amenities	
4.6.4	During ingress and fair proper, as the need arises, additional booth, booth furnishings and amenities, system panels, electrical requirements, e.g., wall panels, convenience outlets, shelves, electrical cords, etc. shall be sourced by the Organizer from the Official Booth Contractor with no on-site order surcharges.	
4.6.5	The Official Contractor must provide an Additional Amenities Order Form with a special discounted rate* only applicable to the Organizer for the whole duration of the event. Standard rates will apply if Exhibitors order on site.	
<b><u>4.7 Other Conditions</u></b>		
4.7.1	The Official Contractor's winning/approved rate shall also apply to all CITEM co-organizers, sponsors and other partners whose booth/setting requirements are coursed through CITEM.	
4.7.2	The Official Contractor may charge a management or supervision and responsibility fee (SRF) to the other booth contractor tapped by any Exhibitor to provide/construct its booth, whether aluminum or non-aluminum. This applies only in case the venue owner charges the official booth contractor a management/accreditation fee. In case of damages, the Official Contractor shall cover all financial obligations and	

	indemnifications found inside the exhibition halls due to the venue owner.	
4.7.3	No management/supervision and responsibility fee shall be billed to the Organizer's contractors and partners working on special setting/areas which will be identified prior the event.	
4.7.4	The Official Contractor shall undertake turn-over to and from venue owner before and after the event.	
4.7.5	The Official Contractor shall be contracted by CITEM for special settings that has 80% aluminum system-based structure.	
4.7.6	The Official Contractor shall provide CITEM copies of its pre-numbered Additional Amenities Order forms for pre-ordered and on-site orders.	
4.7.7	The Official Contractor shall perform its obligations and services in accordance with the best acceptable professional standards and theories of the exhibition industry. It shall exercise reasonable skill, care and diligence in the discharge of the duties agreed to be performed.	
4.7.8	The Official Contractor shall be liable for failure of the facility caused by faulty construction, installation, wiring, etc. It shall hold CITEM and its agents/officers free from any and all liabilities, suits, actions, demands or damages arising from death or injuries to persons and properties, or any loss resulting from or caused by its personnel, incident to or in connection with the services to be performed.	
4.7.9	The Official Contractor shall indemnify, protect and defend at its own expense, CITEM and its agents/officers from and against all actions, claims and liabilities arising out of acts done by its personnel/representatives in the performance of the services.	
4.7.10	The Official Contractor shall bind itself to protect and hold CITEM free and harmless from any suit or liability arising from non-payment of any of the Exhibitors it being understood that the transaction is strictly between the Exhibitor and the contractor.	
4.7.11	The Official Contractor shall ensure that all amenities are delivered and/or services are rendered and are covered by Acknowledgement Receipt.	
4.7.12	Upon acceptance by the Official Contractor, it shall warrant and guarantee to complete and finish all its works, deliverables and services on the agreed time.	
4.7.13	The Official Contractor warrants and shall guarantee all its works, deliverables, and services to be in good condition and in accordance to the best acceptable professional standards and theories of the exhibition industry throughout the duration of the project.	
4.7.14	In case the Official Contractor declines to accept and fulfill CITEM requirements, CITEM has the right to assess and evaluate the validity of the given reasons and may decide to undertake the works on its own or hire the services of other contractor/s, the cost of which shall be deducted from the total contract price payable to the Official Contractor.	
4.7.15	The Official Contractor shall collect the accomplished Additional Amenities Order Forms and Electrical plan from Exhibitors requesting to be serviced. Exhibitors shall settle their electrical consumption and extra orders onsite directly with the Official Contractor depending on filled up forms. The booth package shall be paid by CITEM.	
4.7.16	The Official Contractor shall submit a summary of all serviced on-site orders and submit the same to CITEM one week after the fair.	
4.7.17	The booth quantity estimates may increase or decrease and shall not be the basis for the Official Contractor in providing its services for the above trade show events and amenities;	
4.7.18	The Official Contractor shall warrant that it has not given nor promised to give any amount of money, gifts, or favors to any CITEM official or employee and other third party in order to secure the contract.	
4.7.19	In case of inconsistency in terms and conditions outlined in the above provisions, the decision of CITEM shall prevail.	
4.7.20	The performance of the Official Contractor shall be subjected to a review and evaluation after the project. If the Official Contractor meets/satisfies	



	all obligations and obtains a "Satisfactory" rating, the contract will be extended/enforced for the succeeding edition, if necessary.	
4.7.21	In case the Official Contractor fails to obtain a satisfactory rating, CITEM may opt to cancel its contract and undertake the project/s on its own or negotiate with other contractors. CITEM's decision on the performance of the Official Contractor shall be considered deemed final and binding.	
4.7.22	The Official Contractor shall automatically supply CITEM, as the organizer, with aluminum system requirements if the need arises.	
4.7.23	The Official Contractor must be willing to coordinate with other CITEM contractors to ensure complete delivery of the project.	

I hereby certify that the statement of compliance to the foregoing Technical Specifications are true and correct, otherwise, if found to be false either during bid evaluation or post-qualification, the same shall result to automatic disqualification of our bid.

**CERTIFIED CORRECT:**

\_\_\_\_\_  
Name & Signature of Authorized Representative

\_\_\_\_\_  
Position

**ANNEX A**  
**CONFIRMATION OF FREE OF CHARGE – SYSTEM BASED AMENITIES**

This is to confirm that \_\_\_\_\_ agrees to provide the following amenities to CITEM, **FREE OF CHARGE**:

REQUIREMENTS	DETAILS	DIMENSION	QTY.	REMARKS	PLS. CHECK THE BOX IF AMENABLE TO ARRANGEMENT OF FREE OF CHARGE
1.) Registration Area	Registration Counter Back Wall Storage area Chairs Waste Bins Power Supply Outlets All Graphic Requirements	11.00m x 3.00m x 2.50m H	2 lots	Refer to Annex B for the design	
2.) Prayer Room/Breastfeeding Room	System Structure with panels Lockable Door Partition for Men and Women	6.00m x 2.00m x 2.50m H	1 lot	Refer to Annex B for the design	
3.) Ingress Counter	System Structure with Panel Barstool Power Supply Outlets Waste Bins Info systems inside storage	7.00m x 2.00m x 2.50m H	1 lot	Refer to Annex B for the design	
4.) Baggage Counter	System Structure with panels Shelving	6.00m x 2.00m x 2.50m H	1 lot	Refer to Annex B for the design	
5.) Info Board	5 units – spotlight	6.00m x 0.50m x 2.50m H	2 units	Refer to Annex B for the design	
6.) Lobby Column Cladding	System Structure 4 units – spotlight/structure	2.00m x 1.00m x 2.50m H	2 units	Refer to Annex B for the design	
7.) Lobby Column Accent	Systems Structure 4 units – spotlight/structure	1.00m x 1.00m x 2.50m H	2 units	Refer to Annex B for the design	
8.) Interactive Kiosk Backdrop	Systems Structure	1.00m x 0.50m x 2.50m H	2 units	Refer to Annex B for the design	
9.) Storage False Wall	System Structure Panels	1.00m x 1.00m x 2.50m H (See attached design)	12 units	Refer to Annex B for the design	
10.) Media Lounge Backdrop	System Structure	4.00m x 0.50m x 2.50m H	1 unit	Refer to Annex B for the design	
11.) Seminar Room Backdrop	System Structure	1.00m x 0.50m x 2.50m H	2 units	Refer to Annex B for the design	
12.) Welcome Wall	System Structure with Panel	6.00m x 0.50m x 2.50m H	6 units	Refer to Annex B for the design	
13.) Storage	System Structure with Panels and door	9.00m x 4.00m x 2.50m H	1 lot	Refer to Annex B for the design	
14.) Studio	System Structure with Panels and door	6.00m x 4.00m x 2.50m H	1 lot	Refer to Annex B for the design	

Submitted By:

\_\_\_\_\_  
Signature over Printed Name

\_\_\_\_\_  
Designation

# ANNEX B

## S01 BOOTH COLLATERALS (FREE OF CHARGE) REGISTRATION COUNTER

1 LOT

**MANILA FAME**  
17-19 OCTOBER 2024  
WORLD TRADE CENTER  
METRO MANILA

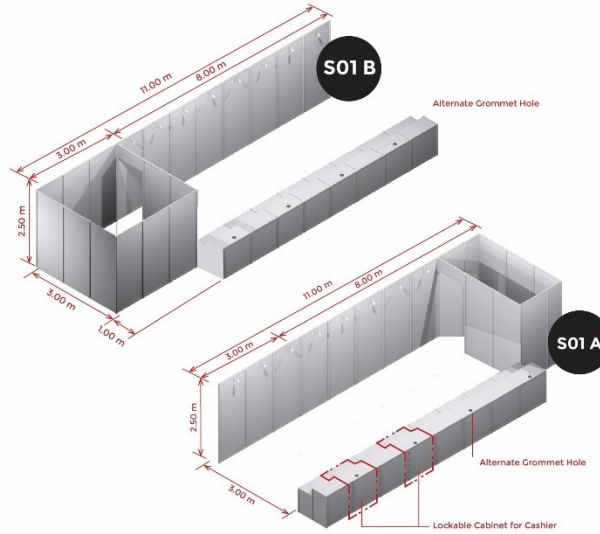
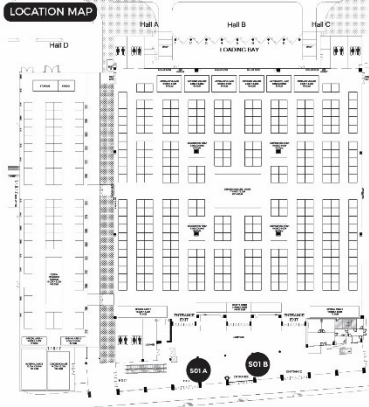

- INCLUSIONS**
- 2 AREAS - RECEPTION COUNTER STRUCTURE
  - 1 LOT - GRAPHICS PRINTING
  - 21 UNITS - SPOTLIGHTS
  - 16 UNITS - 3 GANG CONVENIENCE OUTLET
  - 2 UNITS - LOCKABLE COUNTER
  - 16 UNITS - TRASH BIN
  - 16 UNITS - BLACK CHAIR
  - 2 UNITS - LOCKABLE DRAWER

OFFICIAL BOOTH CONTRACTOR  
SYSTEM REQUIREMENTS

## S02 BOOTH COLLATERALS (FREE OF CHARGE) PRAYER ROOM / BREASTFEEDING ROOM

1 LOT

**MANILA FAME**  
17-19 OCTOBER 2024  
WORLD TRADE CENTER  
METRO MANILA

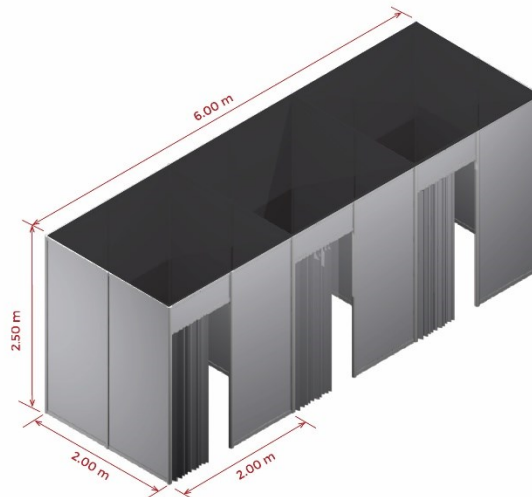
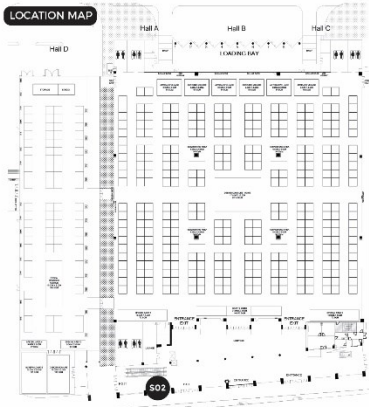

- INCLUSIONS**
- 3 ROOMS - SYSTEM STRUCTURE WITH ACCORDION DOOR
  - 3 UNITS - FLUORESCENT LIGHT
  - 3 UNITS - SYSTEM COUNTER
  - 3 UNITS - CHAIR
  - 1 LOT - STRUCTURE COVER

OFFICIAL BOOTH CONTRACTOR  
SYSTEM REQUIREMENTS

*Note:*  
All drawings are subject to change. Final technical requirements shall be submitted to the Official Booth Contractor once the floor plan has been finalized.

## ANNEX B

### S03 BOOTH COLLATERALS (FREE OF CHARGE) INGRESS COUNTER

1 LOT

**MANILA FAME**  
17-19 OCTOBER 2024  
WORLD TRADE CENTER  
METRO MANILA

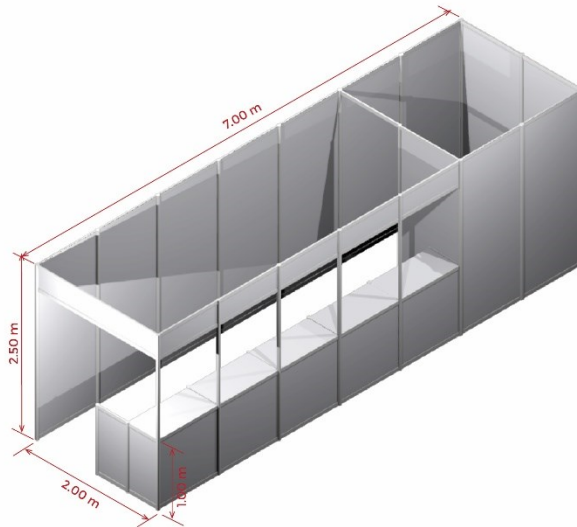
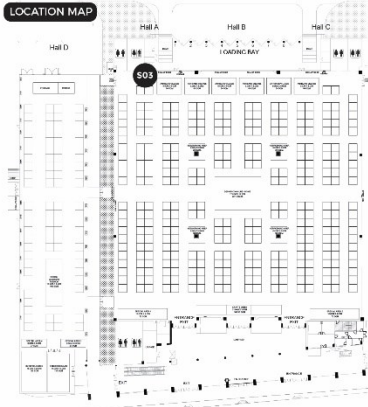

#### INCLUSIONS

- 1 LOT - SYSTEM STRUCTURE
- 5 UNITS - BAR CHAIR
- 3 UNITS - FLUORESCENT LIGHT
- 5 UNITS - CONVENIENCE OUTLET

OFFICIAL BOOTH CONTRACTOR  
SYSTEM REQUIREMENTS

### S04 BOOTH COLLATERALS (FREE OF CHARGE) BAGGAGE COUNTER

1 LOT

**MANILA FAME**  
17-19 OCTOBER 2024  
WORLD TRADE CENTER  
METRO MANILA

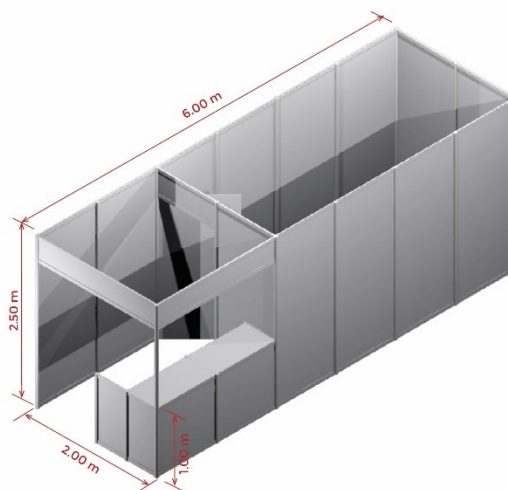
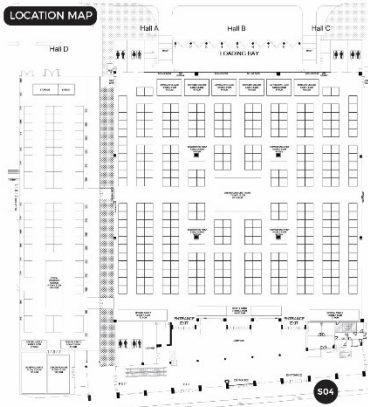

#### INCLUSIONS

- 1 LOT - SYSTEM STRUCTURE
- 2 UNITS - BAR CHAIR
- 1 UNIT - CONVENIENCE OUTLET

OFFICIAL BOOTH CONTRACTOR  
SYSTEM REQUIREMENTS

**Note:**

All drawings are subject to change. Final technical requirements shall be submitted to the Official Booth Contractor once the floor plan has been finalized.

## ANNEX B

### S05 BOOTH COLLATERALS (FREE OF CHARGE) INFO BOARD

2 UNITS

**MANILA FAME**  
17-19 OCTOBER 2024  
WORLD TRADE CENTER  
METRO MANILA

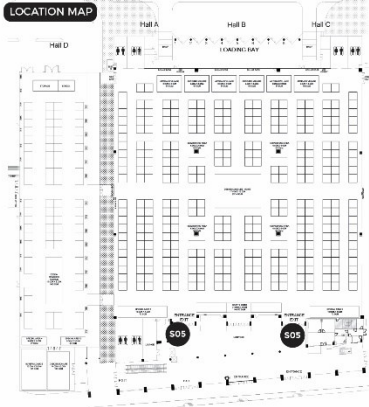

**INCLUSIONS**  
4 UNITS / STRUCTURE - SPOTLIGHT

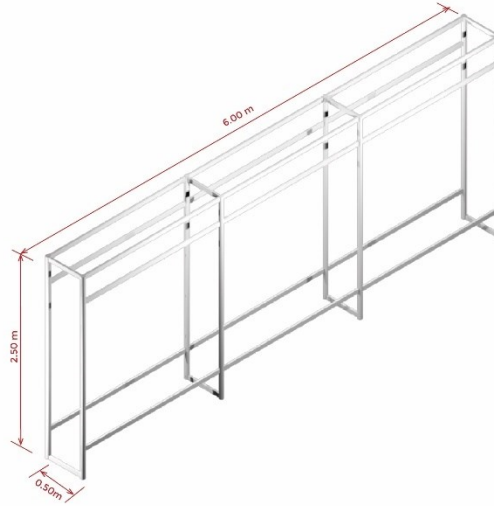

OFFICIAL BOOTH CONTRACTOR  
SYSTEM REQUIREMENTS

### S06 BOOTH COLLATERALS (FREE OF CHARGE) LOBBY COLUMN CLADDING

2 UNITS

**MANILA FAME**  
17-19 OCTOBER 2024  
WORLD TRADE CENTER  
METRO MANILA

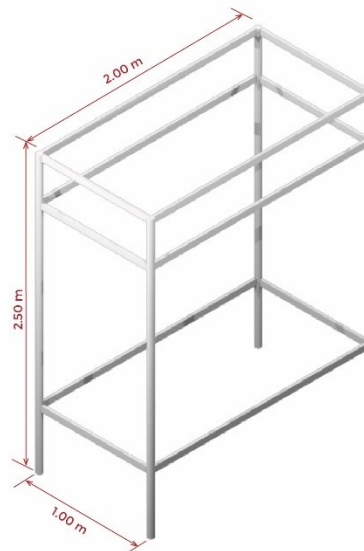
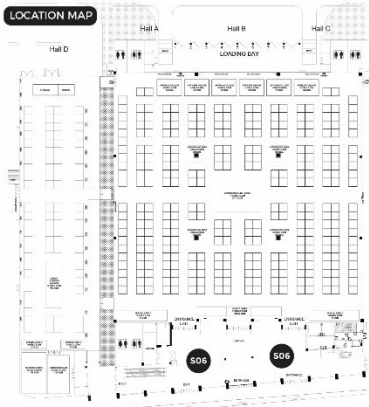

OFFICIAL BOOTH CONTRACTOR  
SYSTEM REQUIREMENTS

*Note:*  
All drawings are subject to change. Final technical requirements shall be submitted to the Official Booth Contractor once the floor plan has been finalized.

## ANNEX B

### S07 BOOTH COLLATERALS (FREE OF CHARGE) LOBBY COLUMN ACCENT

2 UNITS

**MANILA  
FAME**  
17-19 OCTOBER 2024  
WORLD TRADE CENTER  
METRO MANILA

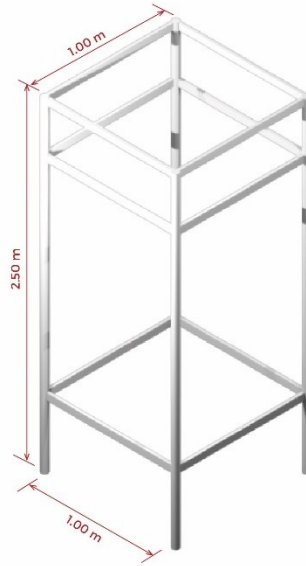
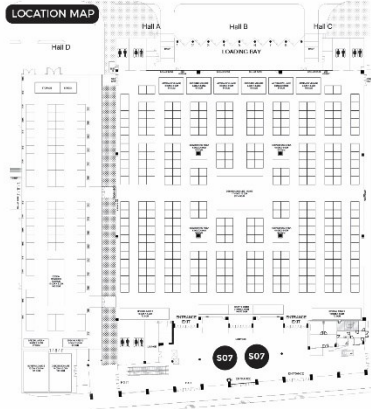

OFFICIAL BOOTH CONTRACTOR  
SYSTEM REQUIREMENTS

### S08 BOOTH COLLATERALS (FREE OF CHARGE) INTERACTIVE KIOSK

2 UNITS

**MANILA  
FAME**  
17-19 OCTOBER 2024  
WORLD TRADE CENTER  
METRO MANILA

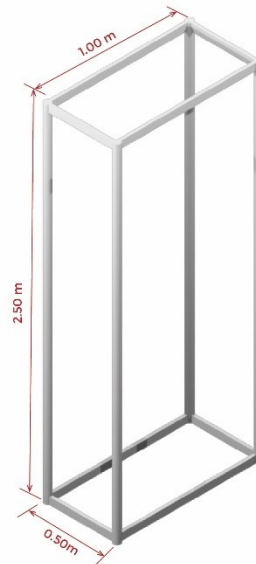
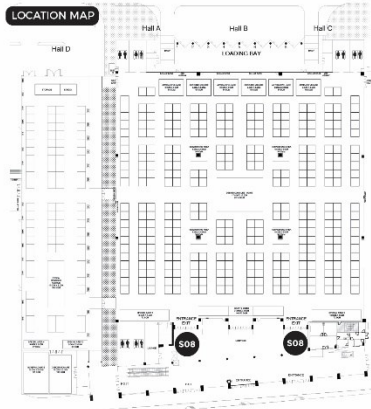

OFFICIAL BOOTH CONTRACTOR  
SYSTEM REQUIREMENTS

**Note:**

All drawings are subject to change. Final technical requirements shall be submitted to the Official Booth Contractor once the floor plan has been finalized.

## ANNEX B

### S09 BOOTH COLLATERALS (FREE OF CHARGE) STORAGE FALSE WALL

12 UNITS

**MANILA FAME**  
17-19 OCTOBER 2024  
WORLD TRADE CENTER  
METRO MANILA

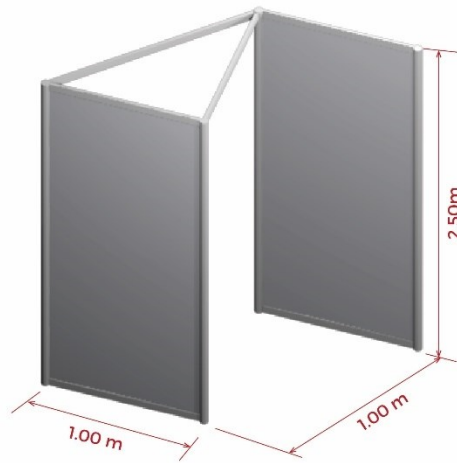
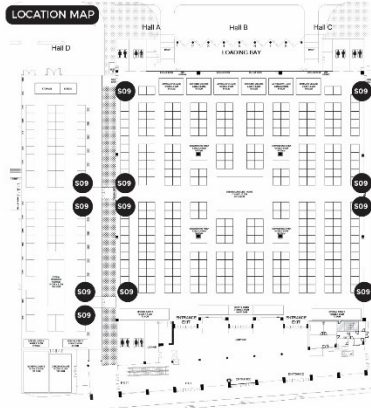

OFFICIAL BOOTH CONTRACTOR  
SYSTEM REQUIREMENTS

### S15 CITEM STUDIO / STORAGE

**MANILA FAME**  
17-19 OCTOBER 2024  
WORLD TRADE CENTER  
METRO MANILA

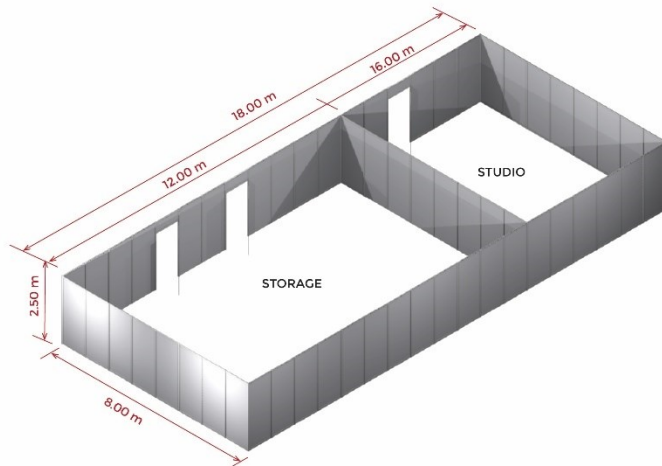

#### INCLUSIONS

- 1 LOT - STRUCTURE
- 3 UNITS - LOCKABLE DOOR
- 13 UNITS - FLUORESCENT LIGHT
- 5 UNITS - CONVENIENCE OULET  
(INSIDE STUDIO)

OFFICIAL BOOTH CONTRACTOR  
SYSTEM REQUIREMENTS

#### Note:

All drawings are subject to change. Final technical requirements shall be submitted to the Official Booth Contractor once the floor plan has been finalized.

# ANNEX B

## S10 BOOTH COLLATERALS (FREE OF CHARGE) MEDIA LOUNGE BACKDROP

1 UNIT



LOCATION MAP

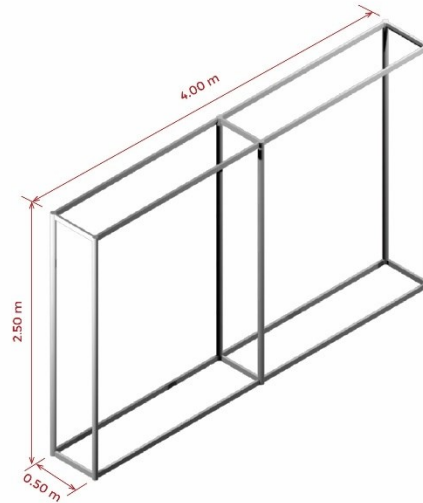
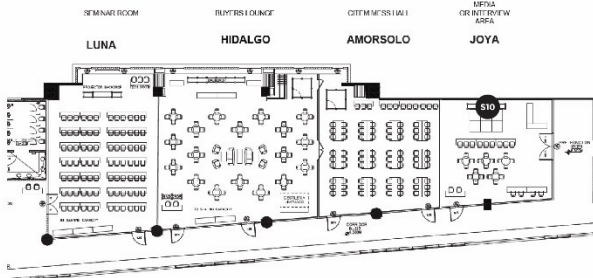

OFFICIAL BOOTH CONTRACTOR  
SYSTEM REQUIREMENTS

## S11 BOOTH COLLATERALS (FREE OF CHARGE) SEMINAR ROOM

2 UNITS



LOCATION MAP

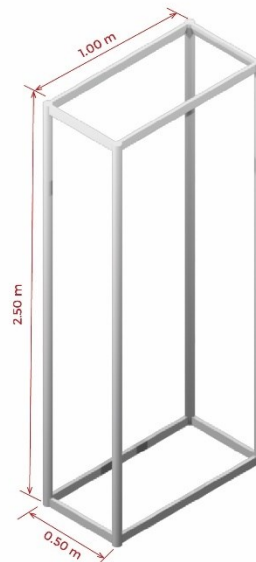
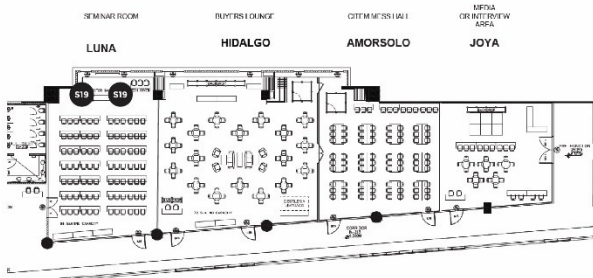

OFFICIAL BOOTH CONTRACTOR  
SYSTEM REQUIREMENTS

**Note:**

All drawings are subject to change. Final technical requirements shall be submitted to the Official Booth Contractor once the floor plan has been finalized.



## ANNEX B

S12

BOOTH COLLATERALS (FREE OF CHARGE)

**WELCOME WALL**

**6 UNITS**

**MANILA  
FAME**  
17-19 OCTOBER 2024  
WORLD TRADE CENTER  
METRO MANILA

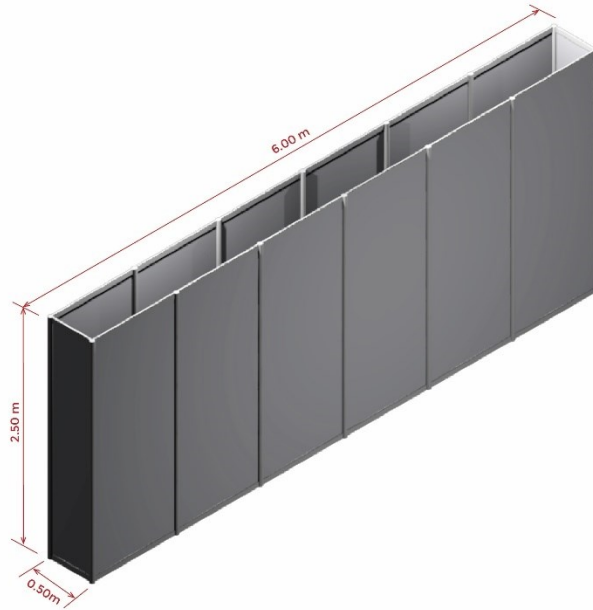

OFFICIAL BOOTH CONTRACTOR  
SYSTEM REQUIREMENTS

S13 & 14

BOOTH COLLATERALS (FREE OF CHARGE)

**STORAGE AND STUDIO**

**1 LOT**

**MANILA  
FAME**  
17-19 OCTOBER 2024  
WORLD TRADE CENTER  
METRO MANILA

LOCATION MAP

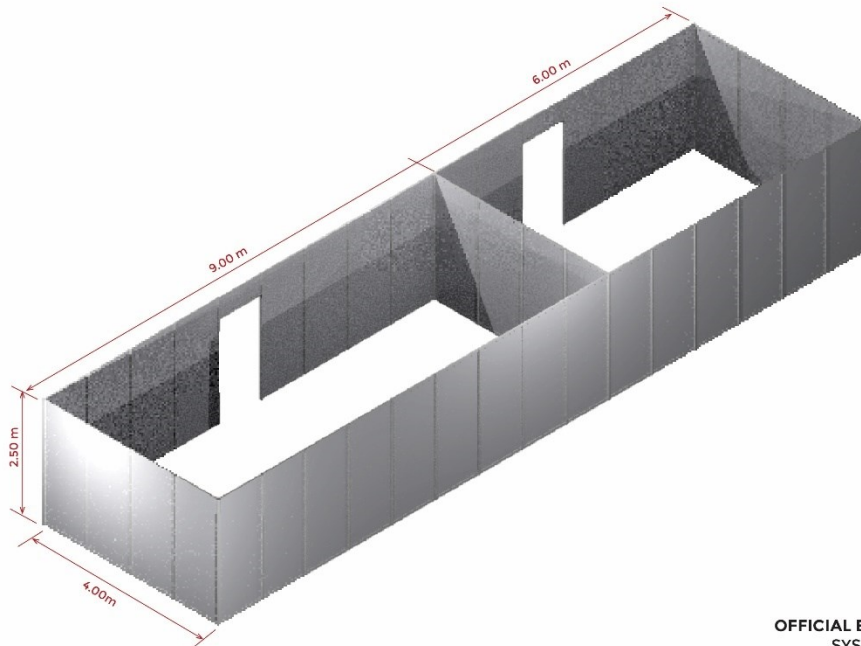

OFFICIAL BOOTH CONTRACTOR  
SYSTEM REQUIREMENTS

**Note:**

All drawings are subject to change. Final technical requirements shall be submitted to the Official Booth Contractor once the floor plan has been finalized.

**ANNEX C**  
**List of Amenities**

NO.	ITEM
	<b>FURNITURE, FIXTURES, &amp; CARPET</b>
1	Stacking Chair
2	Monobloc Chair
3	White Folding Chair
4	Bar Stool White
5	Visitor Chairs with Back rest
6	Info Table
7	System Table Lockable
8	Round Black Laminated Table (60cm dia.)
9	Round Glass Table (90cm dia.) - Cross Legs
10	Cocktail Laminated Table
11	Flat Shelves
12	Brochure Rack
13	Trash Bin
14	Needle Punch (per sqm.) - Used
15	TV Stand
16	Showcase (.5 x 1m x 2m) - Tall/Wide
17	Showcase (.5 x .5m x 2m) - Tall/Narrow
18	Showcase (.5 x 1m x 1m) - Low/Wide
19	Flush Door
	<b>ADDITIONAL PANELS</b>
20	White Panel 1m (w) x 2.5 (h)
21	Clear Acrylic Panel 1m (w) x 2.5 (h) x 3mm thick
22	Colored Panel (1m x 2.5m x 3mm) - 1 side sticker
23	Colored Panel (1m x 2.5m x 3mm) - 2 sides sticker
24	Standard White Panel w/ System Frame
25	White painted wooden panel (1m x 2.4m x 18mm)
	<b>ELECTRICAL FACILITIES</b>
26	Fluorescent Lamp (40w)
27	Long-arm Spotlight LED 12w
28	Short-arm Spotlight LED 12w
29	Floodlights Halogen (150-300w)
30	Floodlights Halogen (500w)
31	Floodlights Metal Halide (150-300w)
32	Floodlights Metal Halide (500w)
33	Convenience Outlet 3gang(300w)

34	Adaptor
35	Outdoor Lighting Requirement
	<b>CIRCUIT BREAKER SINGLE PHASE</b>
36	4.4 Kw with 20 Amp 220V 60 Hz Circuit Breaker
37	6.6 Kw with 30 Amp 220V 60 Hz Circuit Breaker
39	13.2 Kw with 60 Amp 220V 60 Hz Circuit Breaker
	<b>CIRCUIT BREAKER THREE PHASE</b>
40	6.6 Kw with 30 Amp 220V 60 Hz Circuit Breaker
41	13.2 Kw with 60 Amp 220V 60 Hz Circuit Breaker
	<b>DAILY RENTAL FACILITIES</b>
42	43" LED TV with USB ,VGA HDMI ready
43	55" LED TV with USB ,VGA HDMI ready
44	Retractable Stanchion
45	Scaffolding
	<b>OTHER FACILITIES</b>
46	6 CU. Ft. Refrigerator
47	Bar Refrigerator
48	Coffee Maker
49	Water Dispenser w/ 5gals water supply
50	Platform 4ft. x 8 ft. x 4inch thick
51	Water Line with sink (required approval from organizer)
52	Water Line without sink (required approval from organizer)
53	Stage and Rigging
54	RGB Spotlight
55	Automatic Hand Sanitizer
56	Temperature-Measurement & Hand Sanitizer Kiosk
57	Foot Press Alcohol Hand Sanitizer Dispenser
58	Hand Sanitizer – Face Mask – tissue Dispenser Kiosk
59	Sneeze Guard Protection Shield
60	Automatic Footwear Sanitizer
61	Basic Sanitation Tunnel
62	9sqm Carpet with Convenience Outlet 3gang(300w) and 3 Spotlight
63	9sqm Carpet with Convenience Outlet 3gang(300w)
	<b>MANPOWER (VENUE)</b>
64	System Assembler
65	Graphics Artist
66	Carpenter
67	Painter
68	Electrician
69	Utility / Mover

# Checklist of Technical and Financial Documents

## I. TECHNICAL COMPONENT ENVELOPE

### **Class "A" Documents**

#### Legal Documents

- (a) Valid PhilGEPS Registration Certificate (Platinum Membership) (all pages) **in accordance with Section 8.5.2 of the IRR;**

#### Technical Documents

- (b) Statement of the prospective bidder of all its ongoing government and private contracts, including contracts awarded but not yet started, if any, whether similar or not similar in nature and complexity to the contract to be bid; **and**
- (c) Statement of the bidder's Single Largest Completed Contract (SLCC) similar to the contract to be bid, except under conditions provided for in Sections 23.4.1.3 and 23.4.2.4 of the 2016 revised IRR of RA No. 9184, within the relevant period as provided in the Bidding Documents, together with the end user's acceptance or official receipt(s) or sales invoice issued for the contract;; **and**
- (d) Original copy of Bid Security. If in the form of a Surety Bond, submit also a certification issued by the Insurance Commission **or** Original copy of Notarized Bid Securing Declaration; **and**
- (e) Conformity with the Technical Specifications, which may include production/delivery schedule, manpower requirements, and/or after-sales/parts, if applicable; **and**
- (f) Original duly signed Omnibus Sworn Statement (OSS) **and** if applicable, Original Notarized Secretary's Certificate in case of a corporation, partnership, or cooperative; or Original Special Power of Attorney of all members of the joint venture giving full power and authority to its officer to sign the OSS and do acts to represent the Bidder.

#### Financial Documents

- (g) The prospective bidder's computation of Net Financial Contracting Capacity (NFCC) **or A** committed Line of Credit from a Universal or Commercial Bank in lieu of its NFCC computation.

### **Class "B" Documents**

- (h) If applicable, a duly signed joint venture agreement (JVA) in case the joint venture is already in existence **or** duly notarized statements from all the potential joint venture partners stating that they will enter into and abide by the provisions of the JVA in the instance that the bid is successful.

## II. FINANCIAL COMPONENT ENVELOPE

- (i) Original of duly signed and accomplished Financial Bid Form; **and**
- (j) Original of duly signed and accomplished Price Schedule(s).
- (k) Additional Order Form with Rates (Discounted Rate – for CITEM)
- (l) Additional Order Form with Rates (Standard Rate – for Exhibitors)

#### Other documentary requirements under RA No. 9184 (as applicable)

- (m) *[For foreign bidders claiming by reason of their country's extension of reciprocal rights to Filipinos]* Certification from the relevant government office of their country stating that Filipinos are allowed to participate in government procurement activities for the same item or product.
- (n) Certification from the DTI if the Bidder claims preference as a Domestic Bidder or Domestic Entity.

