

FOOD Philippines

The International Food and Beverage Exhibition

FOODEX JAPAN

国際食品・飲料展

TOKYO, JAPAN
11-14 MARCH 2025



FOODEX 2025
PHILIPPINE PAVILION

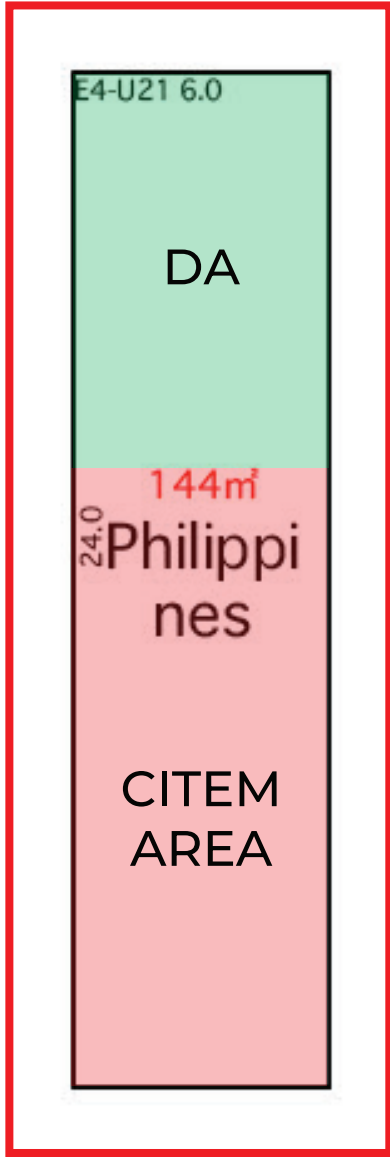

The 50th International Food and Beverage Exhibition
FOODEX JAPAN 2025
国際食品・飲料展

会場: 東京ビッグサイト 東展示棟1-8ホール
会期: 2025年3月11日(火)~14日(金) 10:00~17:00(最終日は16:30まで)
Venue: Tokyo Big Sight East Exhibition Halls 1-8(Tokyo, Japan)
Date: March 11(Tue)14(Fri), 2025 10AM-5PM(4:30PM on the last day)

2024.11.28



出展カテゴリー

お菓子 Confectionery/Sweets	畜産 Livestock	お米 Rice	肉類 Meat	飲料・食品素材 Beverage / Alternative Food	オーガニック食品 Organic Food
FOODEX TECH FOODEX TECH	食品加工機械 Food Safety Machinery	加工食品 Processed Food	冷凍食品 Frozen Food	健康食品 Health Care	スナック・デザート Snacks & Desserts
冷凍スイーツ Frozen Sweets	冷凍加工食品 Frozen Processed Food	冷凍・冷蔵 Frozen / Refrigerated	冷凍加工食品 Frozen Processed Food	冷凍加工食品 Frozen Processed Food	冷凍加工食品 Frozen Processed Food

S=1:700 (A3)

144 sqm
E4 - U21

FOODEX 2025
PHILIPPINE PAVILION

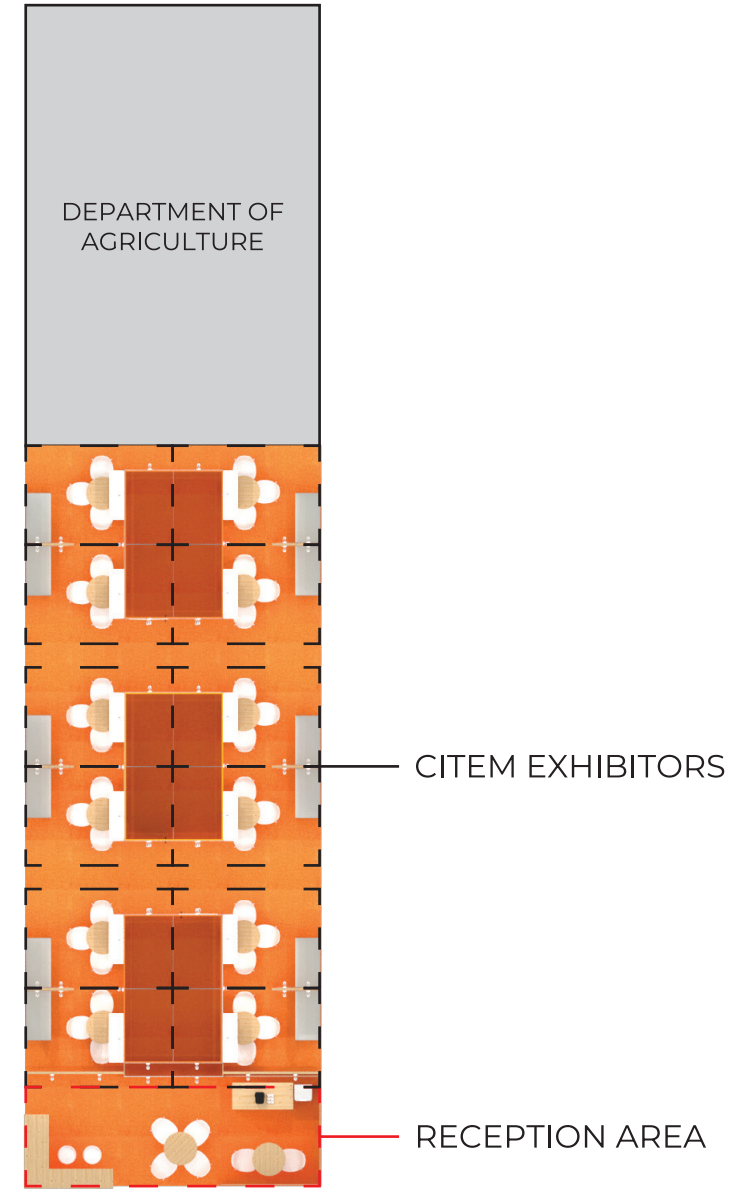
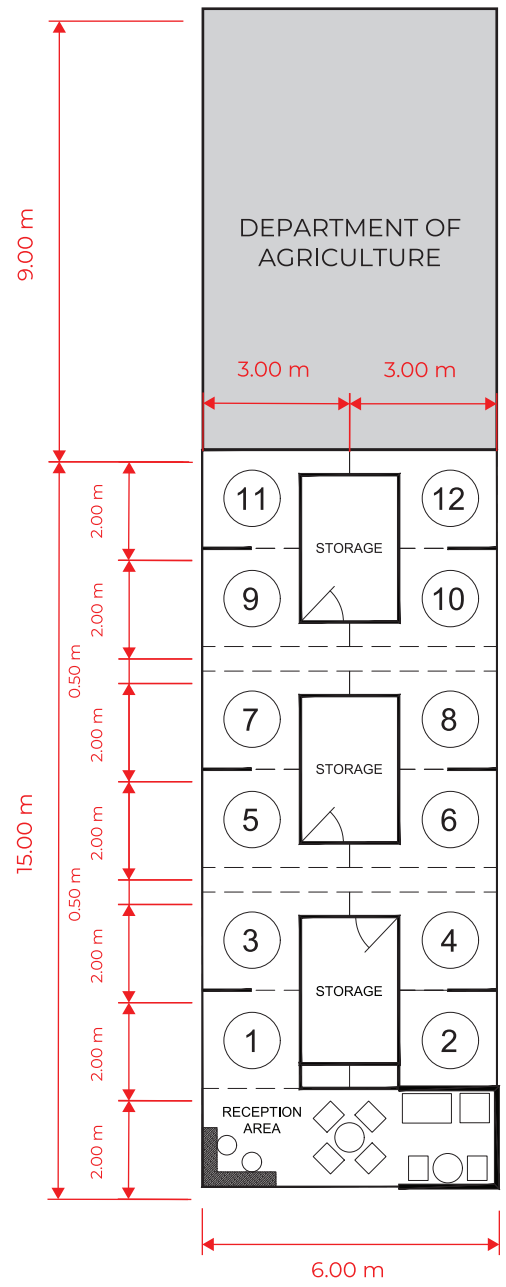

FLOOR LAYOUT

FOODEX 2025
PHILIPPINE PAVILION



DETAILS

FOODEX 2025
PHILIPPINE PAVILION

FRONT

RIGHT PERSPECTIVE

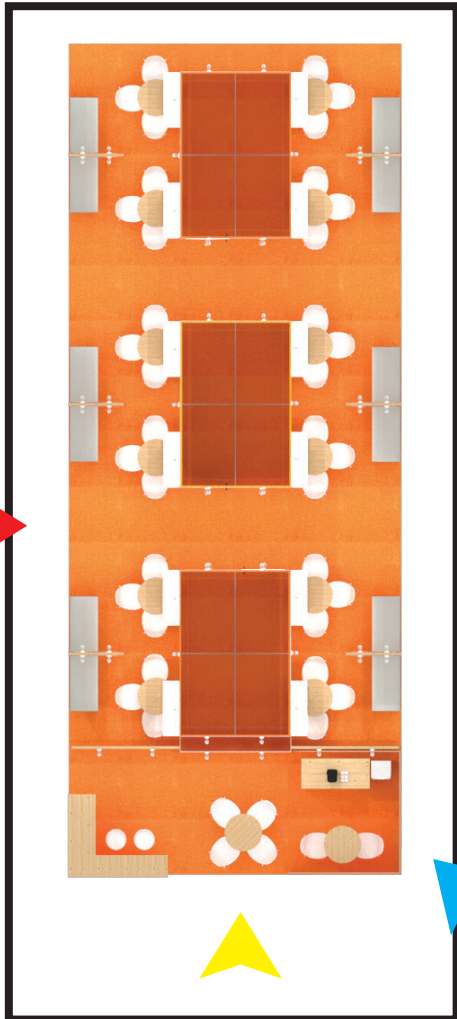

LEFT

PERSPECTIVE VIEWS

FOOD Philippines

The International Food and Beverage Exhibition

FOODEX JAPAN

国際食品・飲料展

TOKYO, JAPAN
11-14 MARCH 2025

PHILIPPINE PAVILION TECHNICAL DRAWINGS



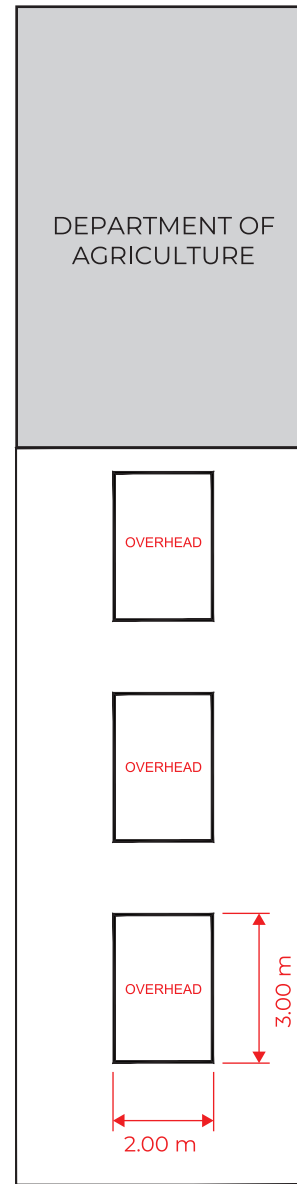
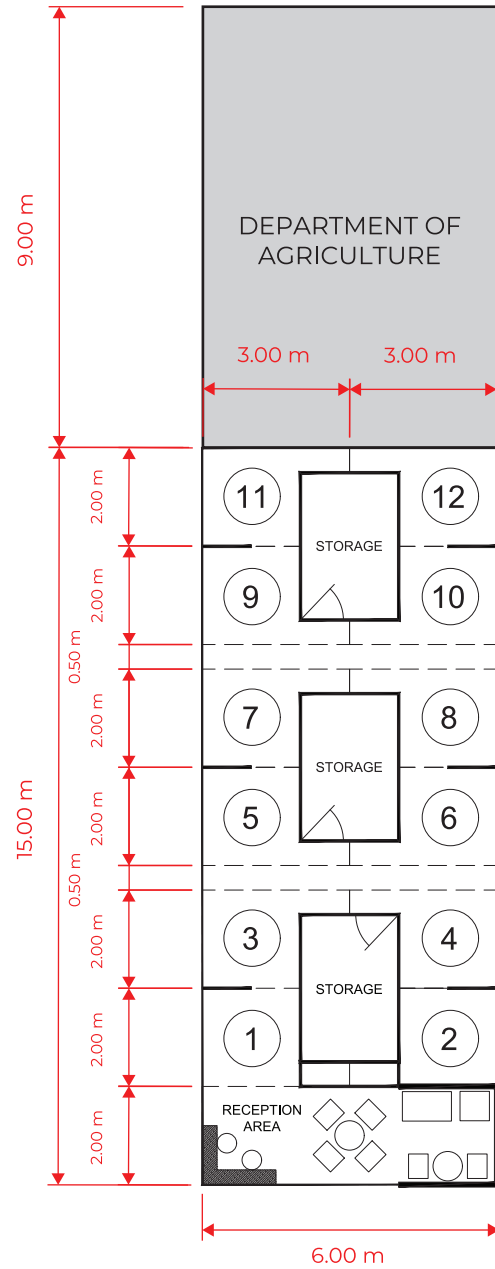



FLOOR LAYOUT PLAN

	PROJECT:	FOODEX 2025	
	TITLE:	PHILIPPINE PAVILION	
DESIGNED BY:	LOCATION:	TOKYO, JAPAN	
DATE/TIME:	LOCATION:	FLOOR LAYOUT PLAN	SHEET NO: 01

FOODEX 2025 - PHILIPPINE PAVILION
 TECHNICAL DRAWINGS

LEGEND:

-  SPOTLIGHTS - DAYLIGHT (42 UNITS)
-  LED STRIP - DAYLIGHT - OVERHEAD (12 UNITS)
-  ELECTRICAL OUTLETS (14 UNITS)

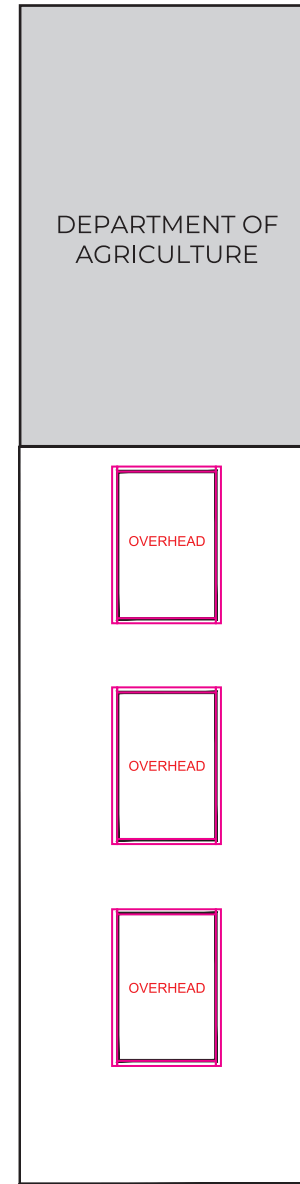
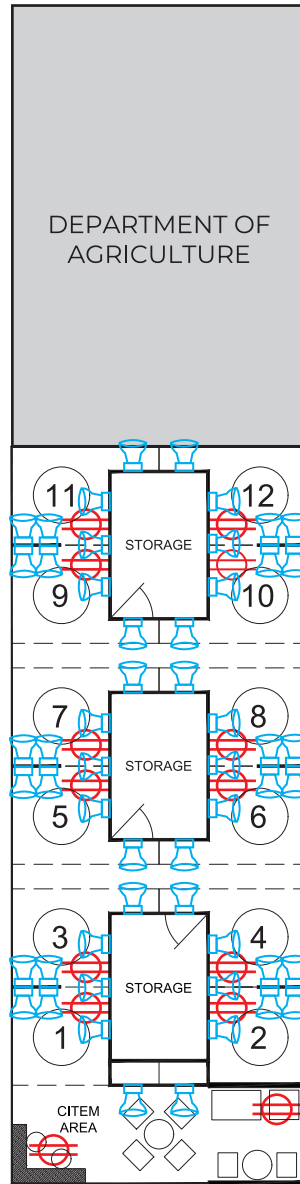

NOTE:
 *CONTRACTOR TO PROVIDE APPROPRIATE CIRCUIT BREAKERS AND PROVIDE RATING

LIGHTING & ELECTRICAL PLAN

	PROJECT:	FOODEX 2025	
	TITLE:	PHILIPPINE PAVILION	
DESIGNED BY:	LOCATION:	TOKYO, JAPAN	
DATE/TIME:	LOCATION:	LIGHTING & ELECTRICAL PLAN	SHEET NO: 02

TECHNICAL DRAWINGS

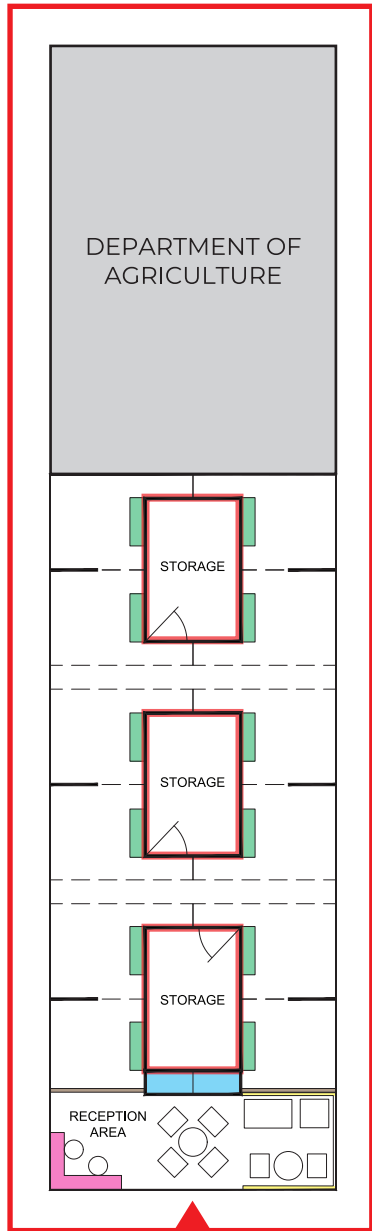

FRONT ELEVATION

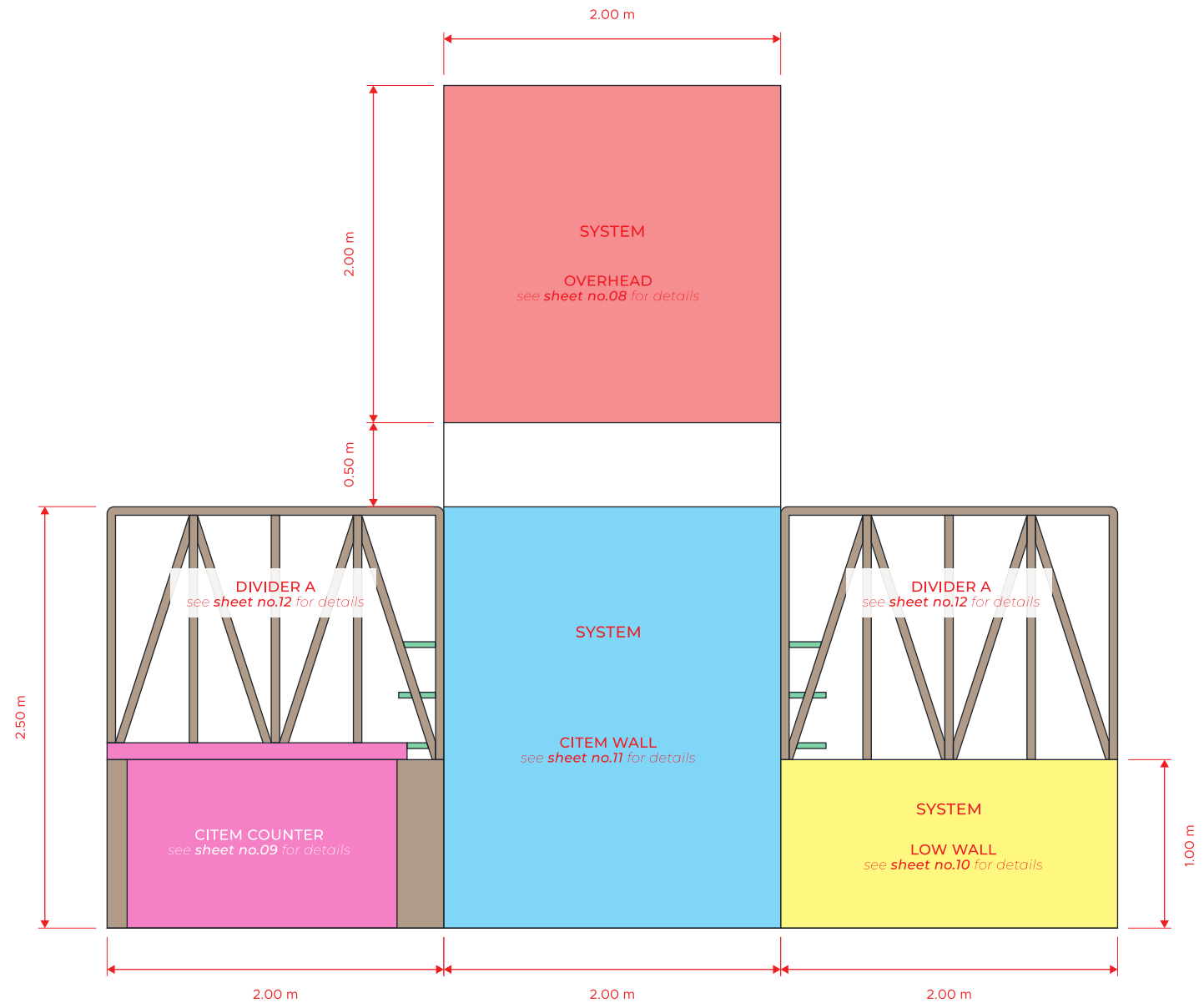

LEGEND:

- SYSTEM OVERHEAD (2.00m x 3.00m x 2.00mH) - 3 LOTS — see *sheet no.08* for details
- SYSTEM CITEM WALL (2.00m x 0.30m x 2.50mH) - 1 LOT — see *sheet no.11* for details
- SYSTEM LOW DIVIDER (2.00m x 1.00mH) - 3 UNITS — see *sheet no.10* for details
- SYSTEM SHELVINGS - 36 UNITS
- DIVIDER A - WOOD PARTITION - 2 UNITS — see *sheet no.12* for details
- CITEM COUNTER - 1 UNIT — see *sheet no.09* for details

	PROJECT: FOODEX 2025	
	TITLE: PHILIPPINE PAVILION	
DESIGNED BY:	LOCATION: TOKYO, JAPAN	
DATE/TIME: 01.23.25	LOCATION: FRONT ELEVATION	SHEET NO: 03

TECHNICAL DRAWINGS

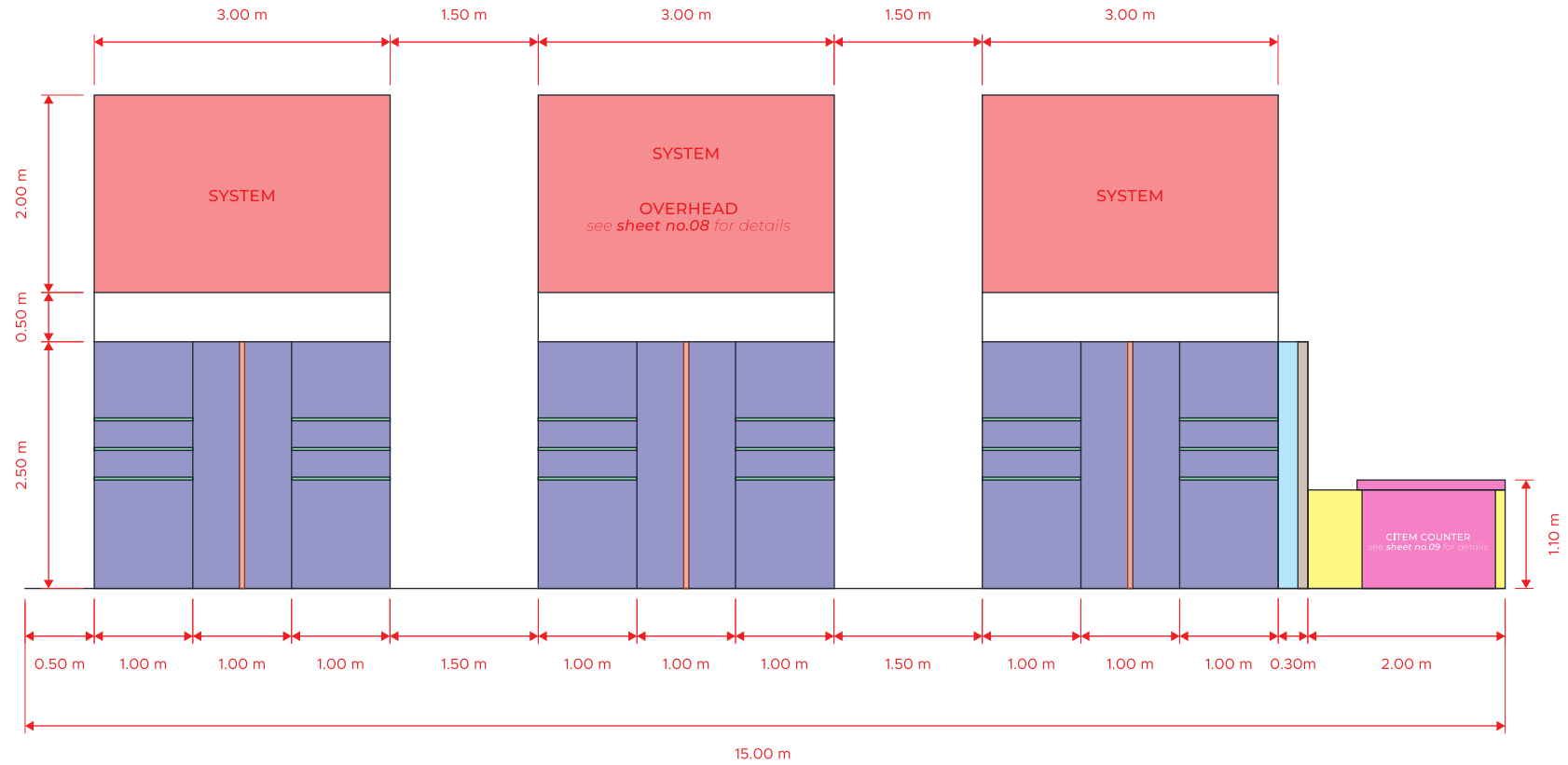
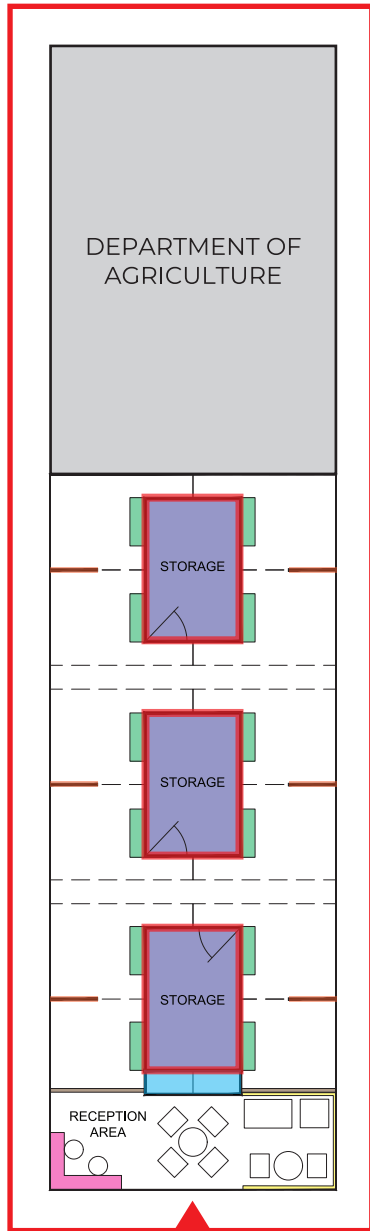

LEGEND:

- SYSTEM OVERHEAD (2.00m x 3.00m x 2.00mH) - 3 LOTS *see sheet no.08 for details*
- SYSTEM CITEM WALL (2.00m x 0.30m x 2.50mH) - 1 LOT *see sheet no.11 for details*
- SYSTEM LOW DIVIDER (2.00m x 1.00mH) - 3 UNITS *see sheet no.10 for details*
- SYSTEM EXHIBITOR SHELVINGS - 36 UNITS
- DIVIDER A - RECEPTION PARTITION - 2 UNITS *see sheet no.12 for details*
- DIVIDER B - EXHIBITOR PARTITION - 6 UNITS *see sheet no.14 for details*
- SYSTEM STORAGE (2.00m x 3.00m x 2.50mH) - 3 LOTS *with graphics outside*
- CITEM COUNTER - 1 UNIT *see sheet no.09 for details*

SIDE ELEVATION

	PROJECT: FOODEX 2025	
	TITLE: PHILIPPINE PAVILION	
DESIGNED BY:	LOCATION: TOKYO, JAPAN	
DATE/TIME: 01.23.25	LOCATION: SIDE ELEVATION	SHEET NO: 04

FOODEX 2025 - PHILIPPINE PAVILION
TECHNICAL DRAWINGS

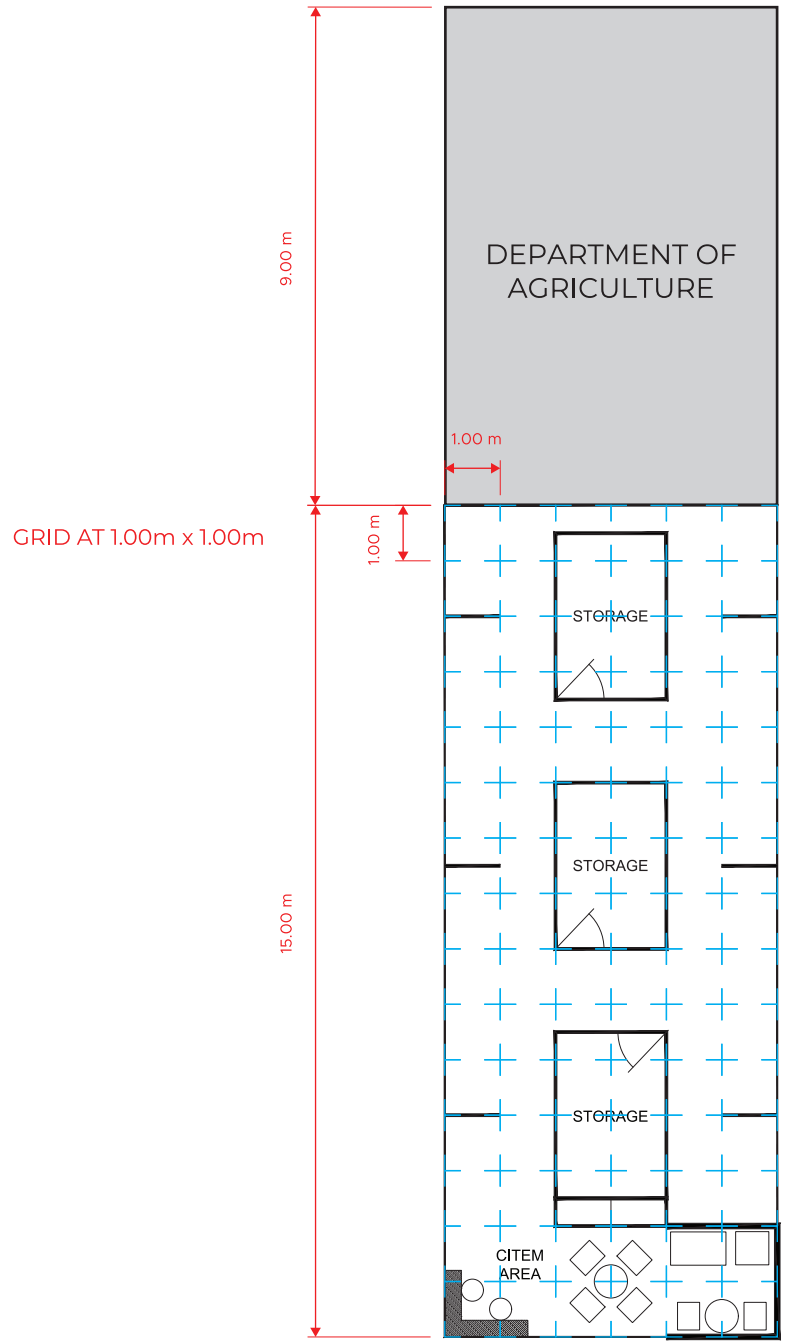

GRID FLOOR LAYOUT PLAN

	PROJECT:	FOODEX 2025
	TITLE:	PHILIPPINE PAVILION
DESIGNED BY:	LOCATION:	TOKYO, JAPAN
DATE/TIME:	LOCATION:	SHEET NO.
01.23.25	GRID LAYOUT PLAN	05

TECHNICAL DRAWINGS

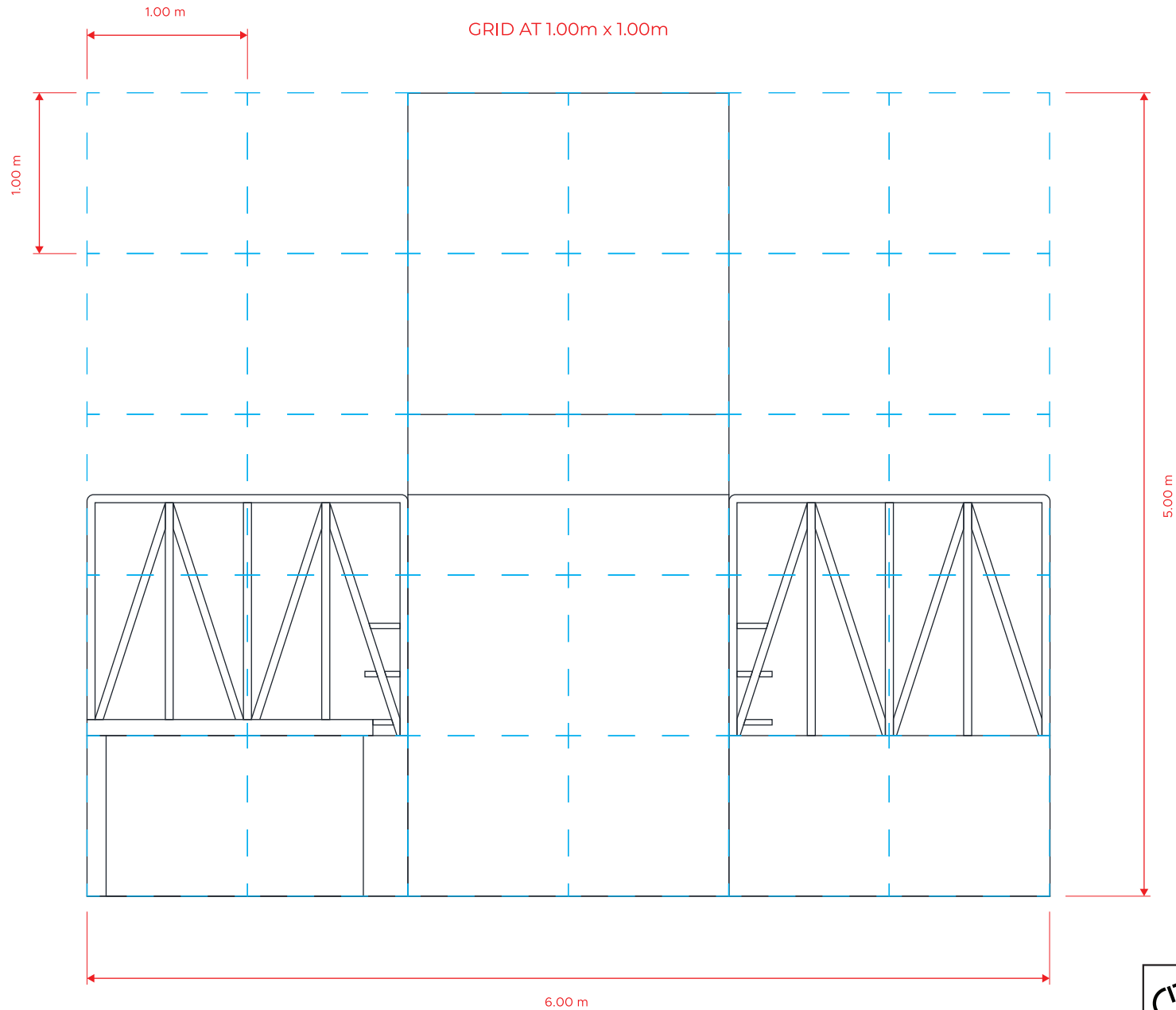

GRID FRONT LAYOUT PLAN

	PROJECT:	FOODEX 2025	
	TITLE:	PHILIPPINE PAVILION	
DESIGNED BY:	LOCATION:	TOKYO, JAPAN	
DATE/TIME:	LOCATION:	GRID LAYOUT PLAN	SHEET NO: 06

TECHNICAL DRAWINGS

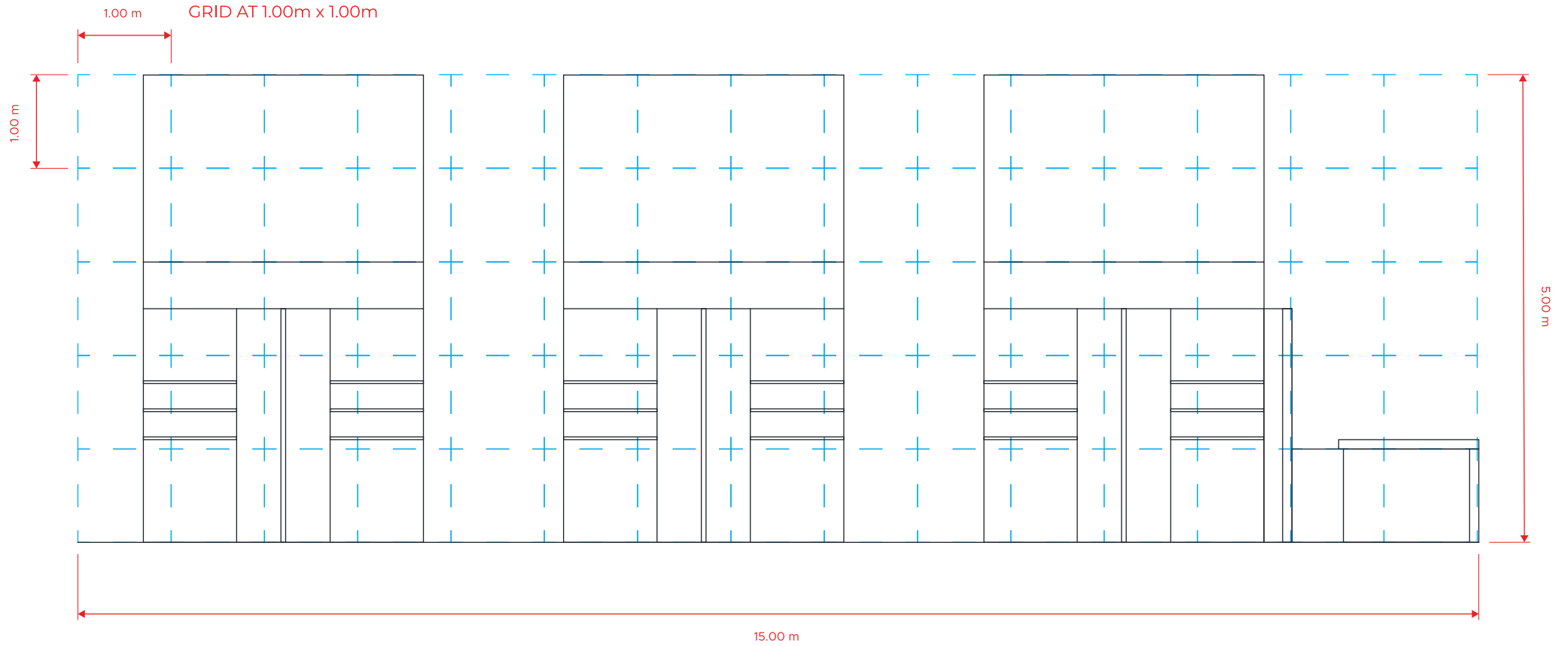

GRID SIDE LAYOUT PLAN

	PROJECT:	FOODEX 2025	
	TITLE:	PHILIPPINE PAVILION	
DESIGNED BY:	LOCATION:	TOKYO, JAPAN	
DATE/TIME:	LOCATION:	GRID LAYOUT PLAN	SHEET NO: 07

FOODEX 2025 - PHILIPPINE PAVILION
 TECHNICAL DRAWINGS

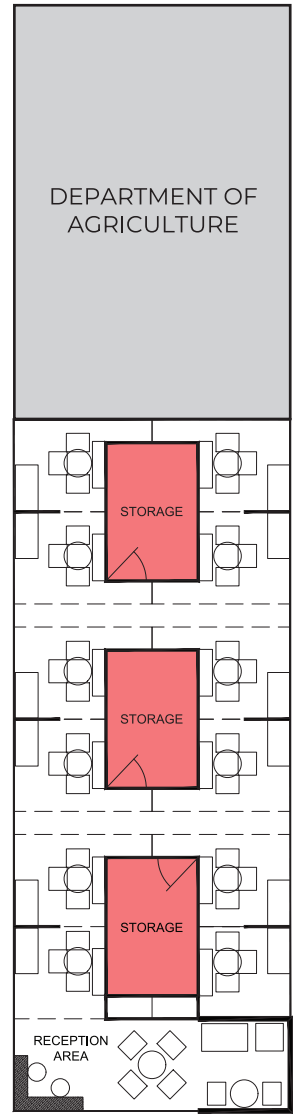
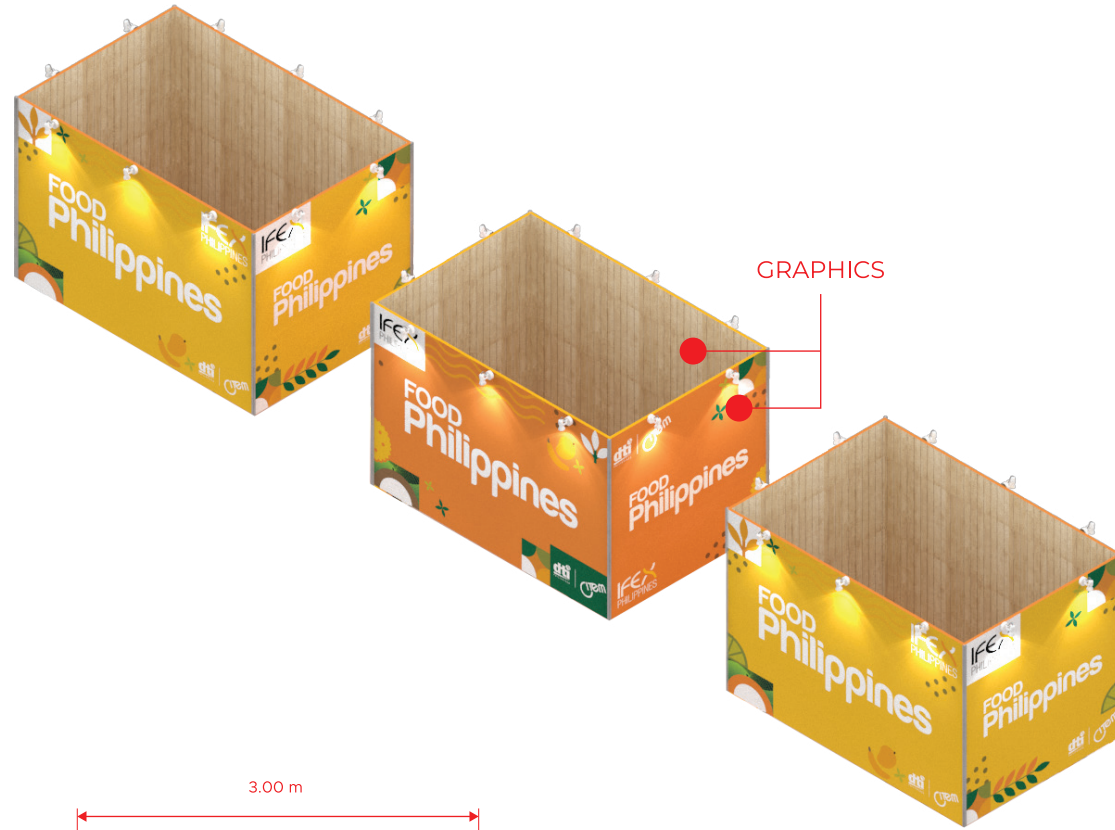
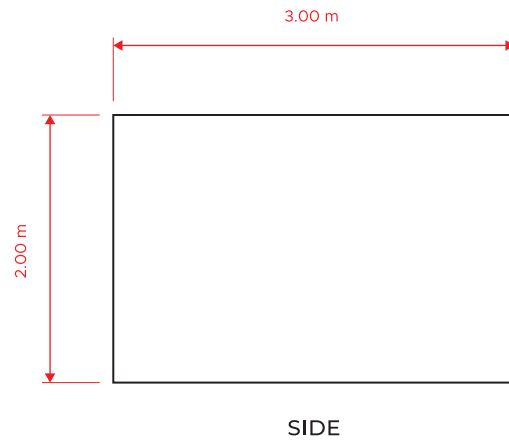
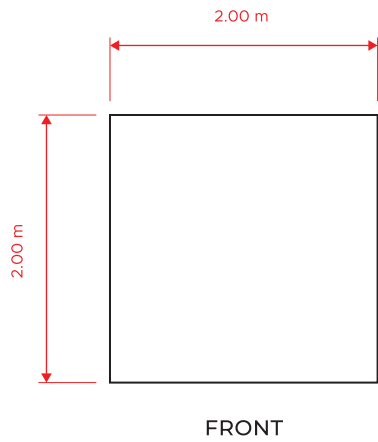
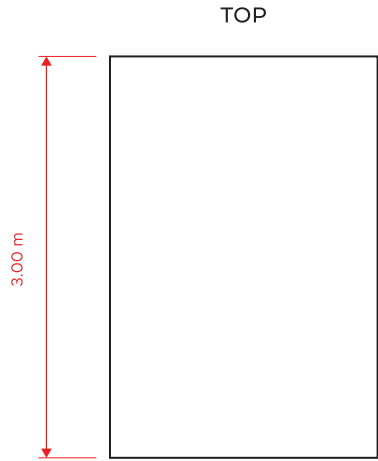

3 LOTS
 OVERHEAD DETAILS

	PROJECT:	FOODEX 2025	
	TITLE:	PHILIPPINE PAVILION	
DESIGNED BY:	LOCATION:	TOKYO, JAPAN	
DATE/TIME:	LOCATION:	OVERHEAD DETAILS	SHEET NO: 08

FOODEX 2025 - PHILIPPINE PAVILION
 TECHNICAL DRAWINGS

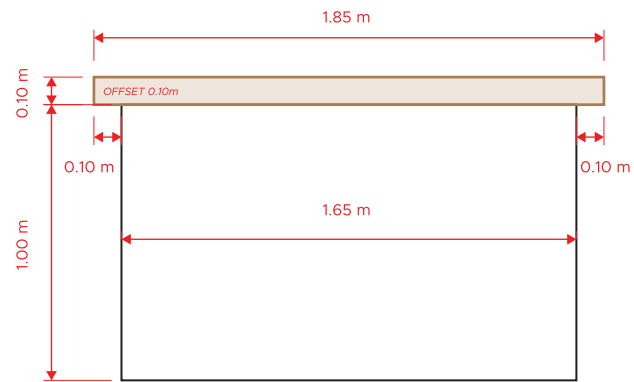
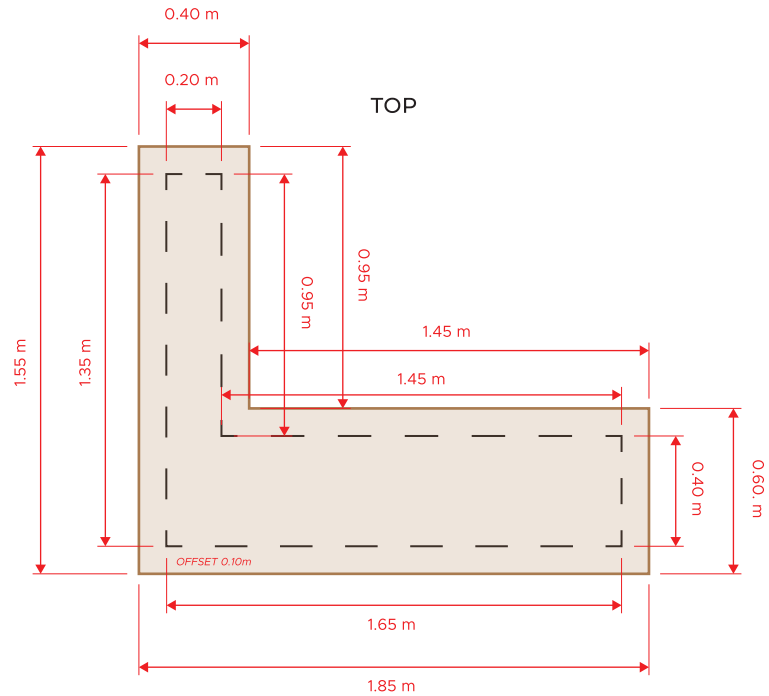

FRONT

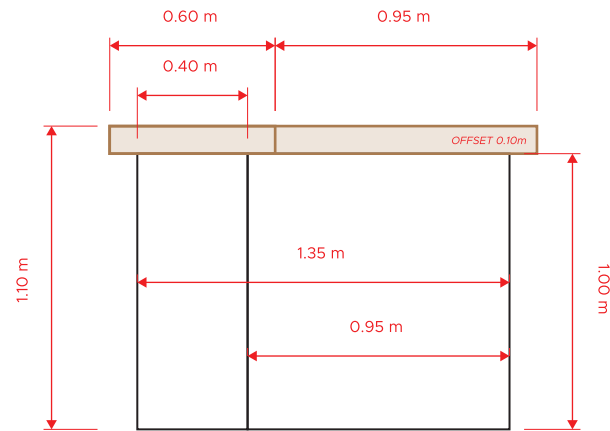

SIDE



GRAPHICS

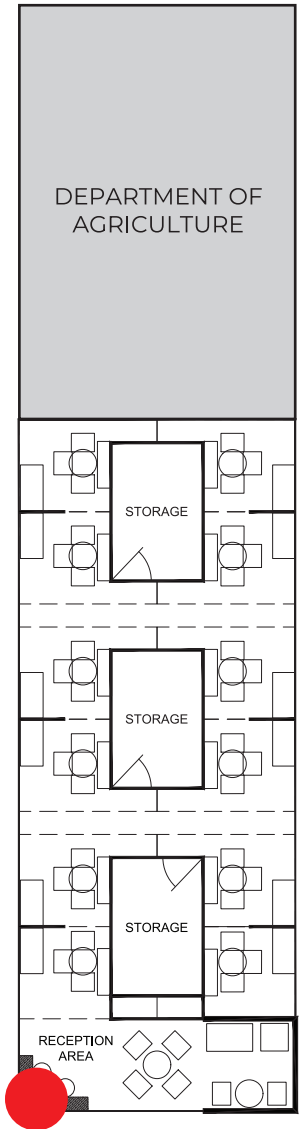

1 UNIT
 CITEM L-TYPE RECEPTION COUNTER (with cabinet)

	PROJECT:	FOODEX 2025	
	TITLE:	PHILIPPINE PAVILION	
DESIGNED BY:	LOCATION:	TOKYO, JAPAN	
DATE/TIME:	LOCATION:	RECEPTION COUNTER	SHEET NO. 09

FOODEX 2025 - PHILIPPINE PAVILION
 TECHNICAL DRAWINGS

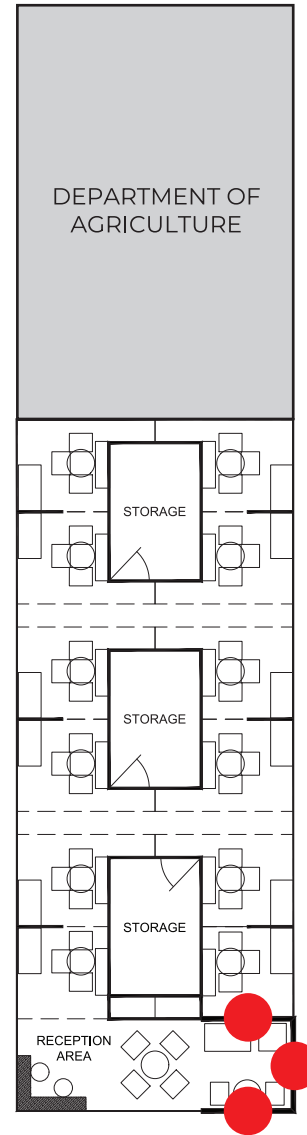
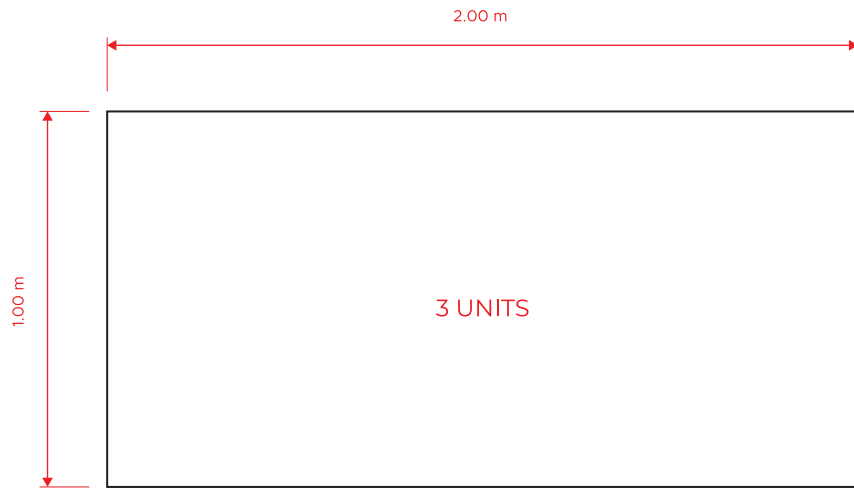
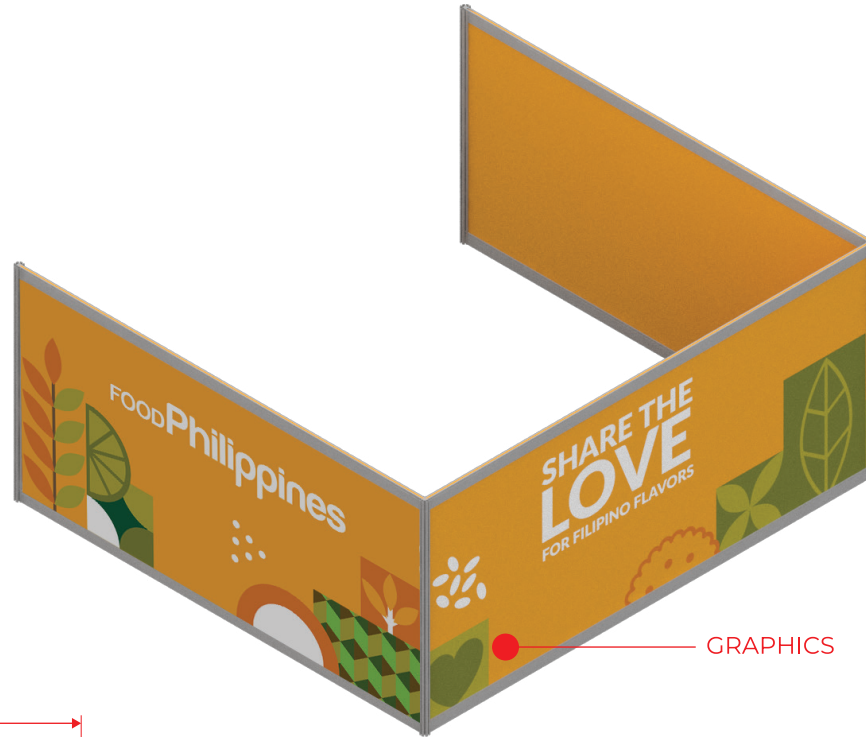

1 LOT
 LOW WALL DIVIDER (reception area)

	PROJECT:	FOODEX 2025	
	TITLE:	PHILIPPINE PAVILION	
DESIGNED BY:	LOCATION:	TOKYO, JAPAN	
DATE/TIME:	LOCATION:	LOW WALL DIVIDER	SHEET NO: 10

FOODEX 2025 - PHILIPPINE PAVILION
 TECHNICAL DRAWINGS

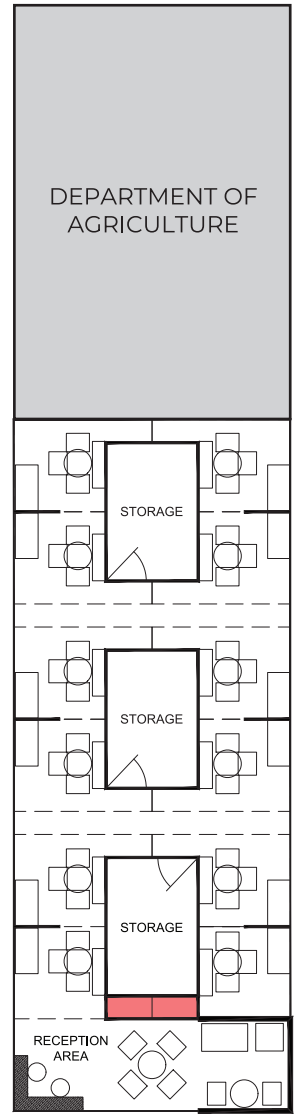
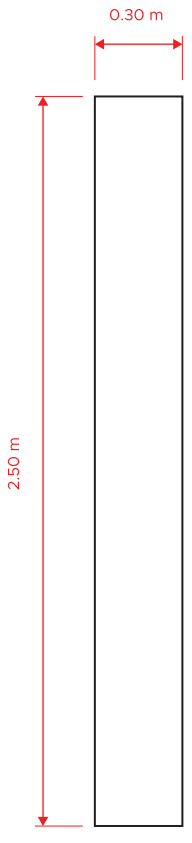
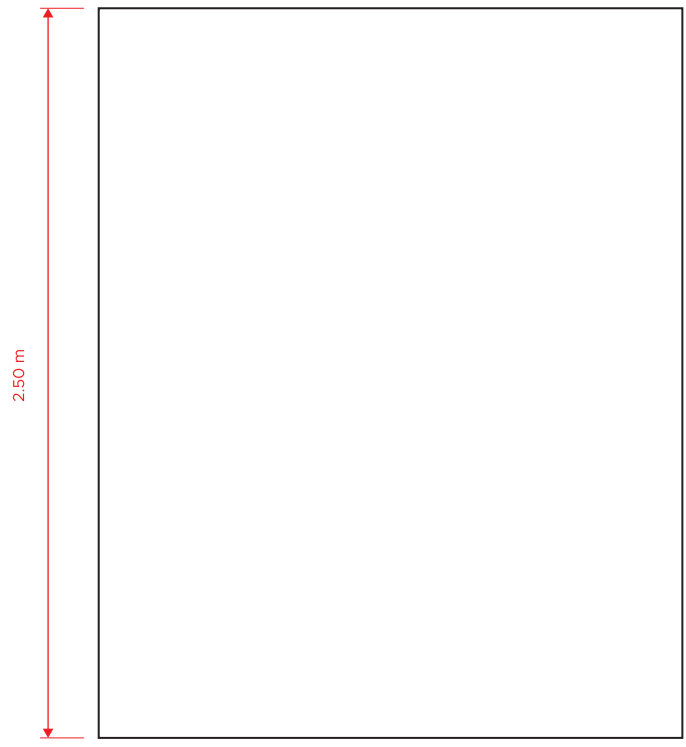
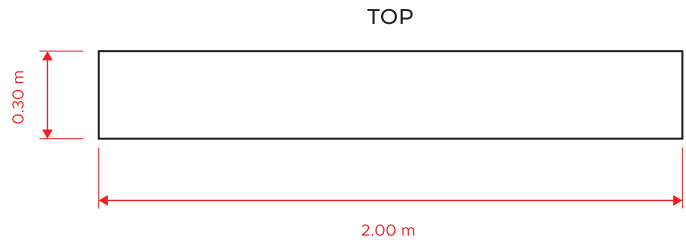

1 LOT
 CITEM WALL (connected to storage)

	PROJECT:	FOODEX 2025
	TITLE:	PHILIPPINE PAVILION
DESIGNED BY:	LOCATION:	TOKYO, JAPAN
DATE/TIME:	LOCATION:	SHEET NO.:
01.23.25	CITEM WALL	11

FOODEX 2025 - PHILIPPINE PAVILION
 TECHNICAL DRAWINGS

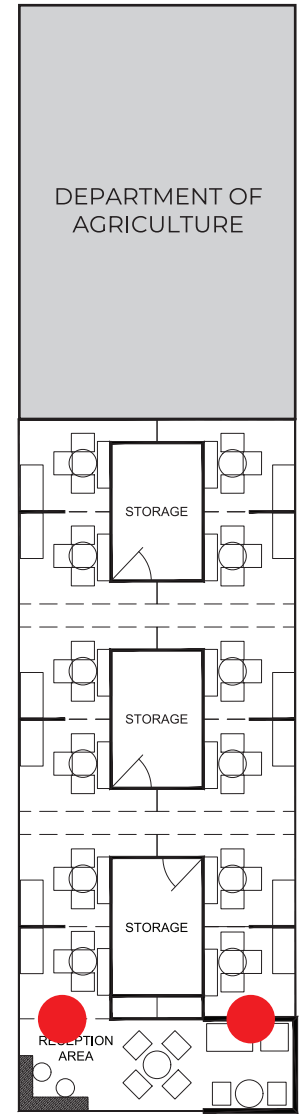
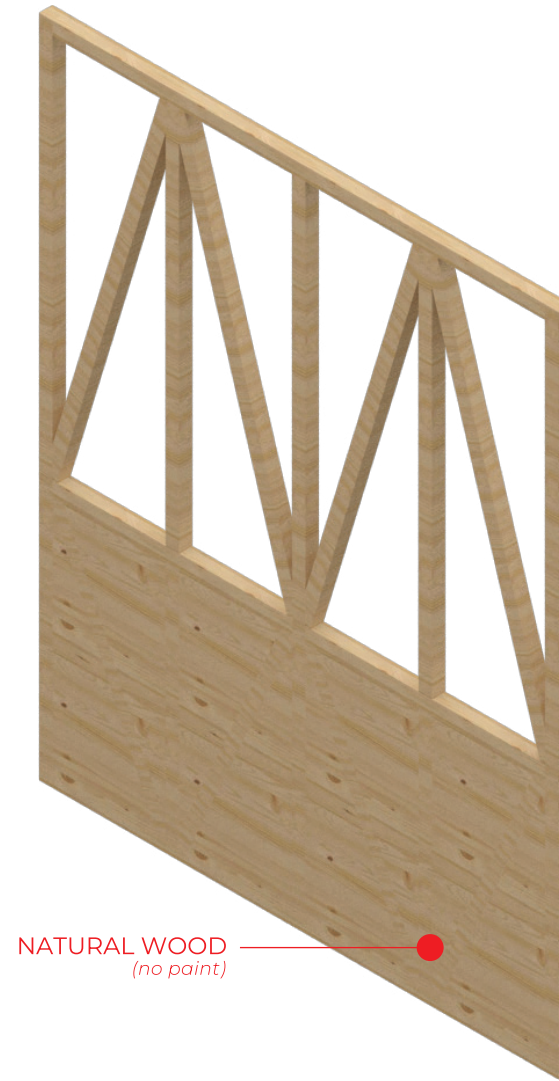
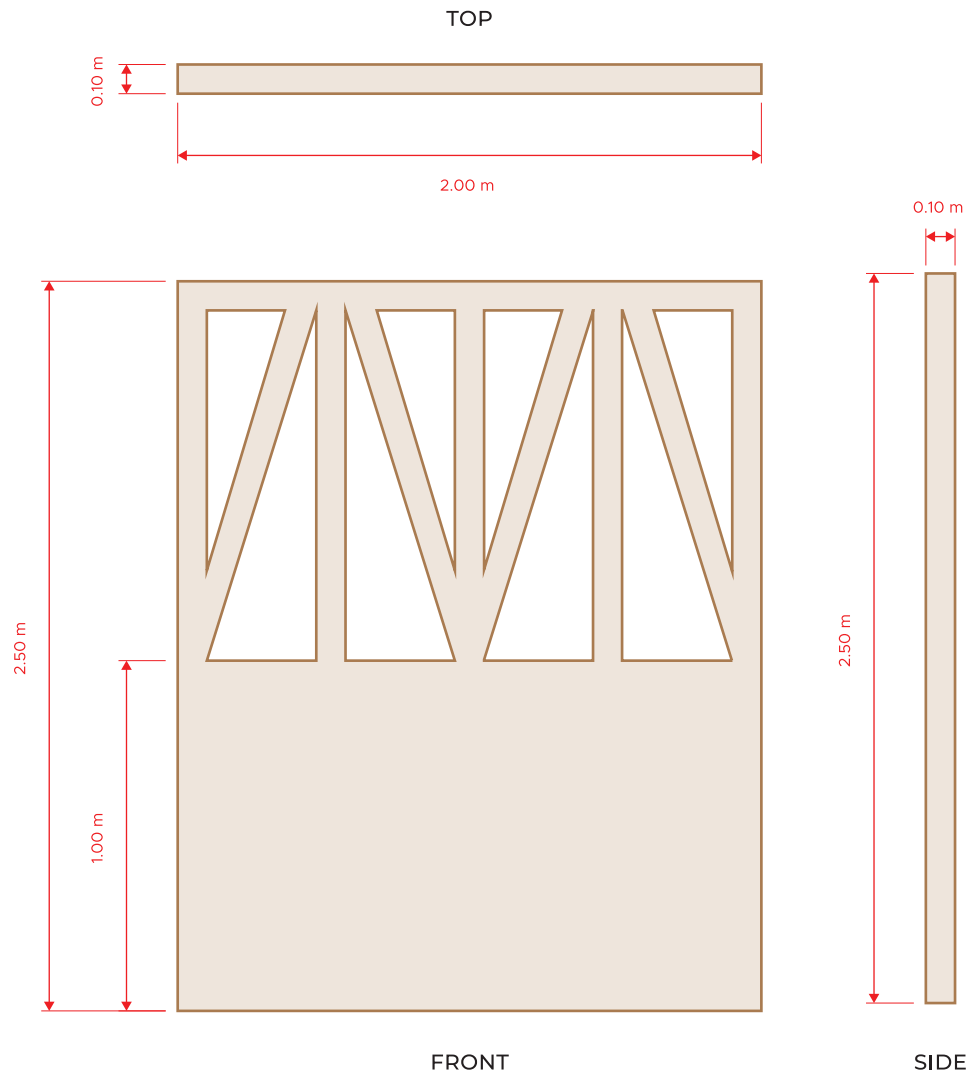

2 UNITS
 DIVIDER A PARTITION DETAILS

	PROJECT:	FOODEX 2025	
	TITLE:	PHILIPPINE PAVILION	
DESIGNED BY:	LOCATION:	TOKYO, JAPAN	
DATE/TIME:	LOCATION:	PARTITION DETAILS	SHEET NO: 12

FOODEX 2025 - PHILIPPINE PAVILION

TECHNICAL DRAWINGS

CITEM RECEPTION AREA:

- 1 UNIT - RECEPTION COUNTER
- 2 UNITS - BAR STOOL
- 2 UNITS - ROUND TABLES
- 6 UNITS - CHAIRS
- 1 LOT - COFFEE NOOK
- 1 LOT - WATER DISPENSER
- 1 LOT - LOW DIVIDER
- 2 UNITS - DIVIDER A
- 1 LOT - CITEM WALL
- 1 UNIT - TRASHBIN

see **sheet no.02** for lighting and electrical layout

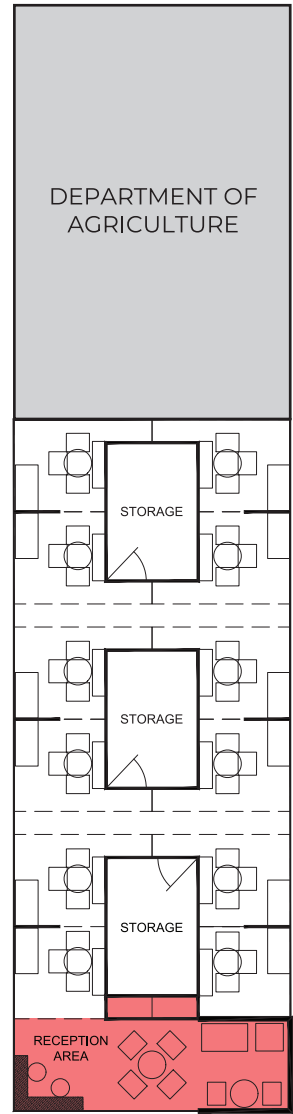

1 LOT RECEPTION AREA DETAILS

	PROJECT:	FOODEX 2025
	TITLE:	PHILIPPINE PAVILION
DESIGNED BY:	LOCATION:	TOKYO, JAPAN
DATE/TIME: 01.23.25	LOCATION:	RECEPTION AREA
		SHEET NO: 13

TECHNICAL DRAWINGS

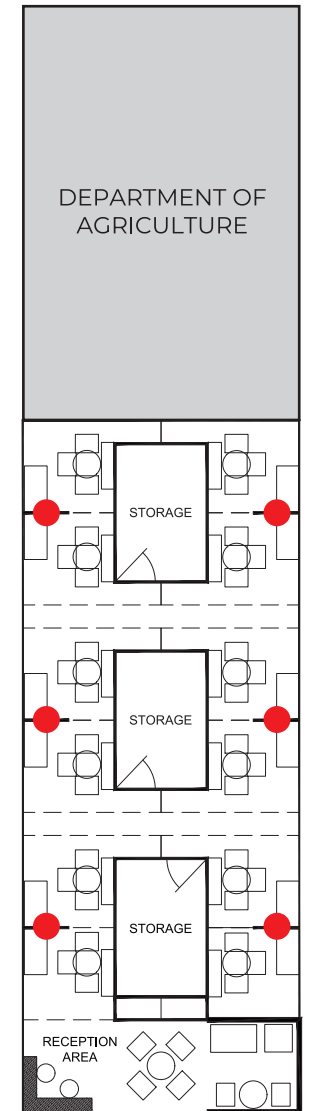
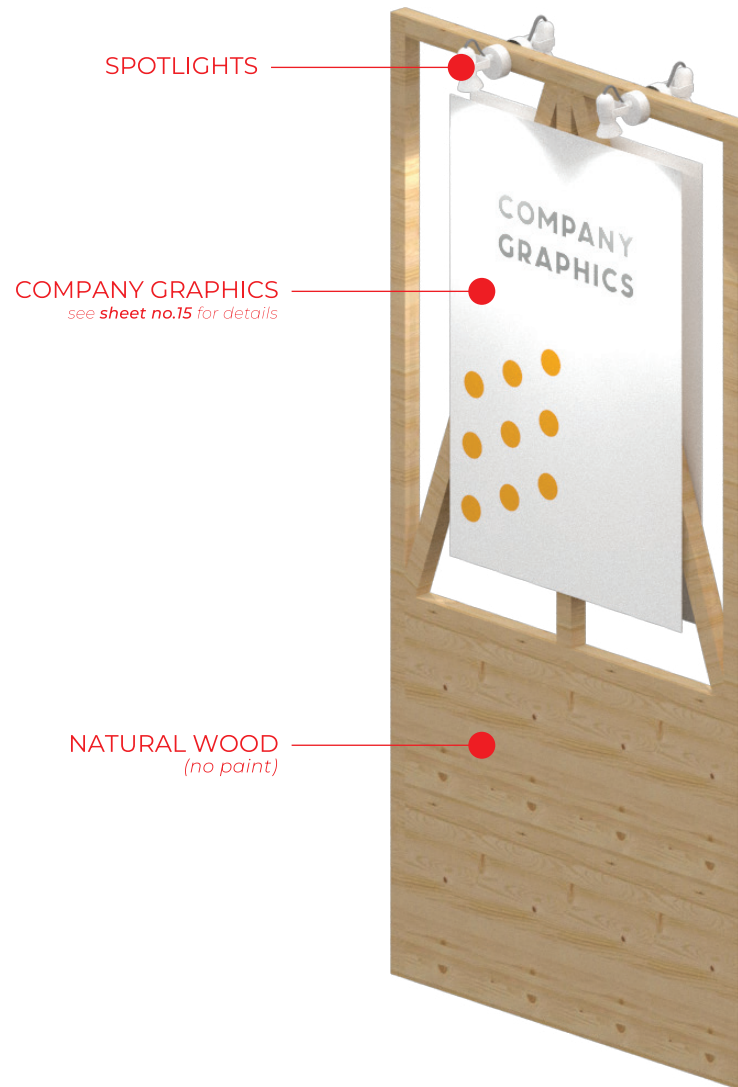
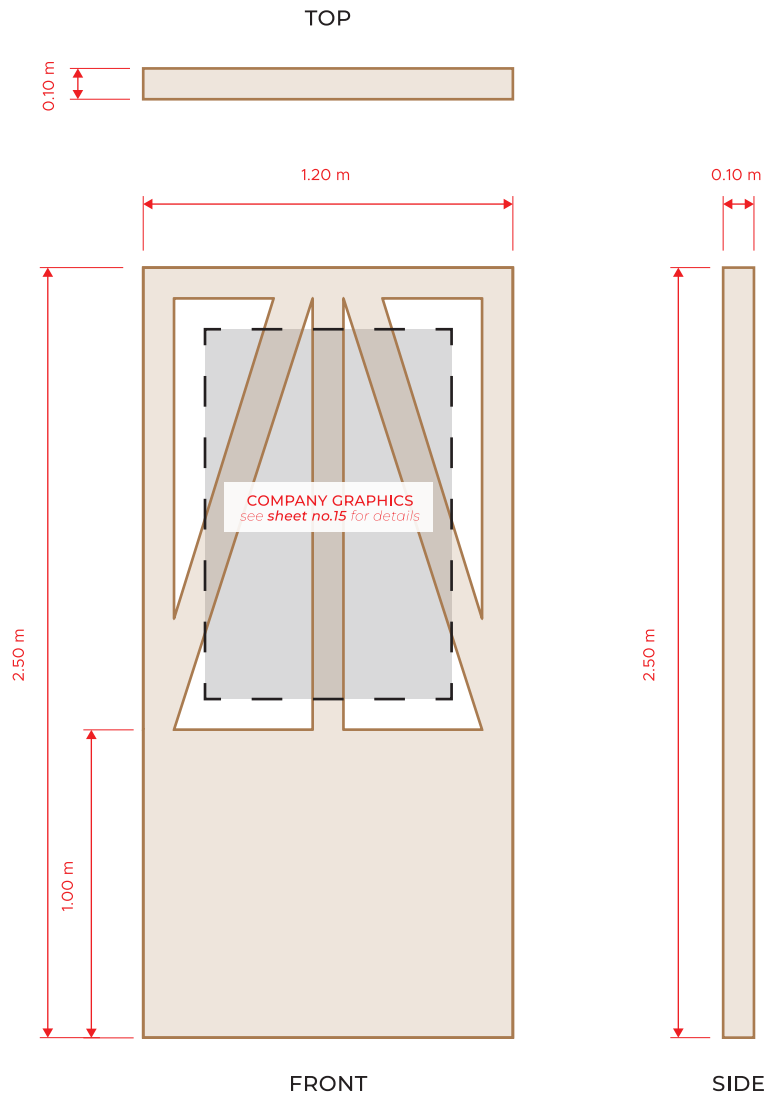

6 UNITS
DIVIDER B PARTITION DETAILS

	PROJECT:	FOODEX 2025	
	TITLE:	PHILIPPINE PAVILION	
DESIGNED BY:	LOCATION:	TOKYO, JAPAN	
DATE/TIME:	LOCATION:	PARTITION DETAILS	SHEET NO: 14

FOODEX 2025 - PHILIPPINE PAVILION
 TECHNICAL DRAWINGS

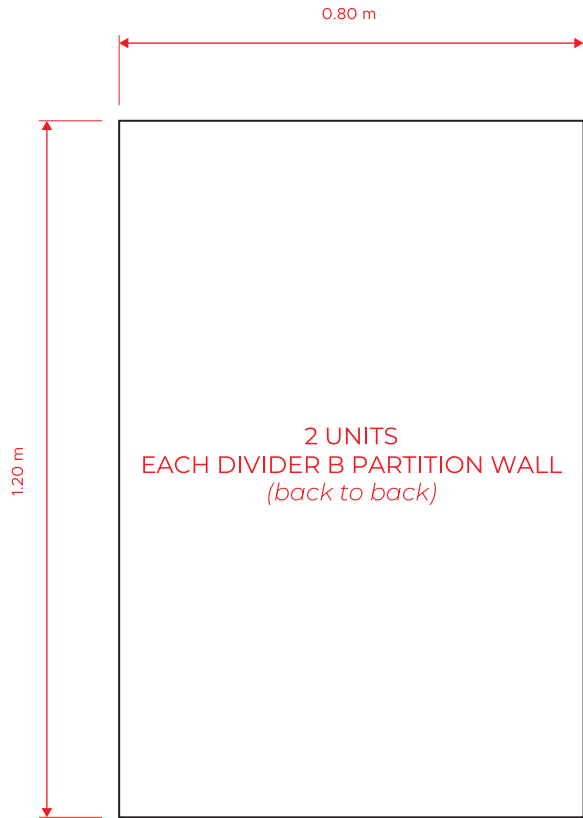

COMPANY GRAPHICS

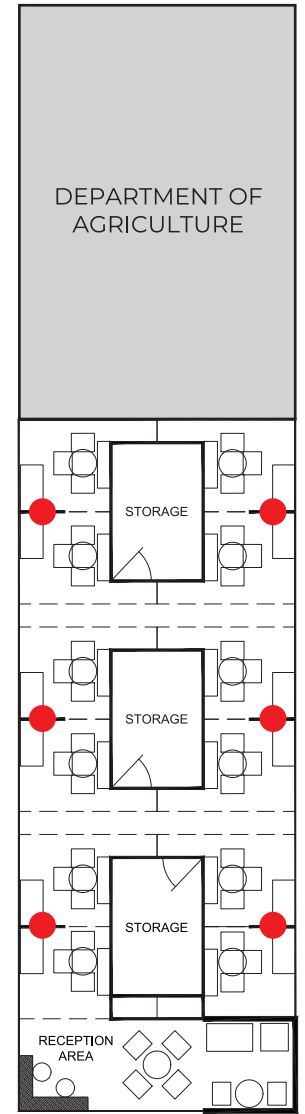
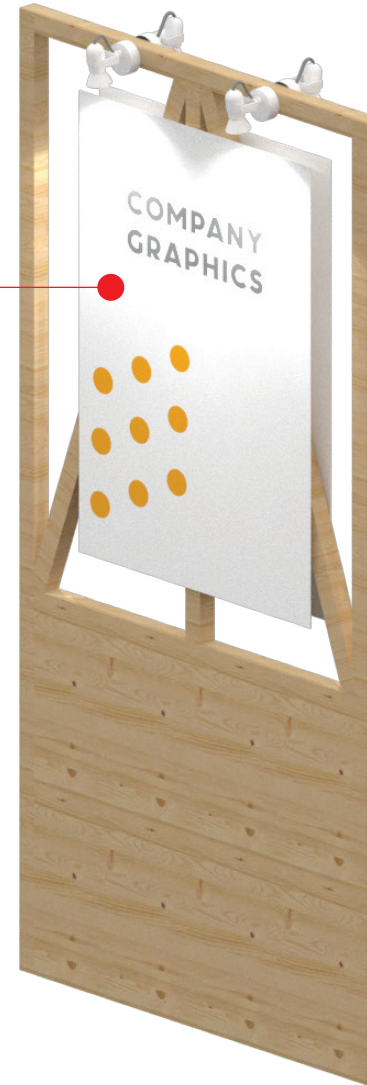

12 UNITS
COMPANY GRAPHICS

	PROJECT:	FOODEX 2025	
	TITLE:	PHILIPPINE PAVILION	
DESIGNED BY:	LOCATION:	TOKYO, JAPAN	
DATE/TIME:	LOCATION:	COMPANY GRAPHICS	SHEET NO: 15

FOODEX 2025 - PHILIPPINE PAVILION TECHNICAL DRAWINGS

PER EXHIBITOR AREA:

- 1 UNIT - DISPLAY COUNTER
- 1 UNIT - DIVIDER B
- 1 UNIT - COMPANY GRAPHICS
- 3 UNITS - SHELVINGS
- 1 UNIT - ROUND TABLE
- 3 UNITS - CHAIRS
- 1 UNIT - TRASHBIN
- 1 LOT - SHARING STORAGE

see *sheet no.02* for lighting and electrical layout



DEPARTMENT OF AGRICULTURE

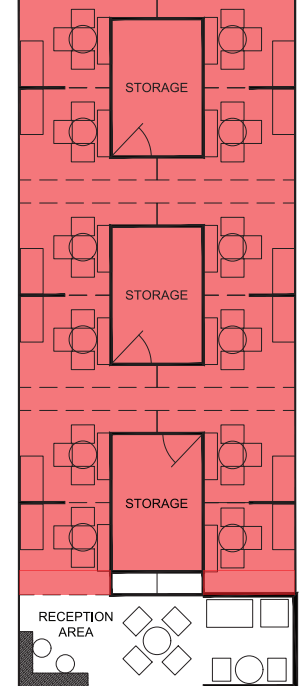

12 EXHIBITORS
EXHIBITOR AREA DETAILS

Citem	PROJECT:	FOODEX 2025
	TITLE:	PHILIPPINE PAVILION
DESIGNED BY:	LOCATION:	TOKYO, JAPAN
DATE/TIME: 01.23.25	LOCATION:	EXHIBITOR AREA
		SHEET NO: 16

PAVILION				
ITEM NO.	PARTICULARS	QTY	UNIT	DESCRIPTION
1	PAVILION STRUCTURE	1	LOT	6.00m x 15.00m x 5.00mH System with Overhead, Storage Area and Graphics
2	FLOORING	90	SQM	Needle Punch Orange Carpet (or any available near Orange Color)
3	OVERHEAD	3	LOTS	2.00m x 3.00m x 2.00mH System Overhead with Graphics
4	CITEM RECEPTION COUNTER	1	UNIT	CITEM Reception L-Type Counter with Wooden Overtop and Graphics
5	DIVIDER A	2	UNITS	2.00m x 2.50mH (Free Standing Natural Wood Reception Partition Wall)
6	DIVIDER B	6	UNITS	1.20m x 2.50mH (Free Standing Natural Wood Exhibitor Partition Wall)
7	EXHIBITOR GRAPHICS	12	UNITS	0.80m x 1.20mH Company Graphics (Mounted in Divider B Partition Walls)
8	EXHIBITOR DISPLAY COUNTER	12	UNITS	System Display Glass Showcase Counters with Graphics
9	SHELVINGS	36	UNITS	System Shelvings (3 per exhibitor)
10	COMPANY NAME	12	UNITS	1.00m x 2.50mH Company Name Graphics (Mounted on System Panel)
11	ROUND TABLES	14	UNITS	0.60 Diameter Table
12	CHAIRS	42	UNITS	Standard White Chair
13	BAR STOOL	2	UNITS	White Bar Stool for CITEM Reception Counter
14	COFFEE NOOK TABLE	1	UNIT	System Counter Table with Storage for condiments
15	COFFEE MAKER	1	UNIT	Commercial Coffee Maker (Placed in Coffee Nook Area)
16	CONDIMENTS	1	LOT	Coffee, Creamer & Sugar (Placed in Coffee Nook Area)
17	PAPER CUPS & STIRRER	1	LOT	100 Cups/Day (Placed in Coffee Nook Area)
18	WATER DISPENSER	1	UNIT	Hot and Cold Water Dispenser (Floor Standing - Placed beside Coffee Nook Area)
19	WATER GALLON	1	LOT	Water Gallon (3 GAL/Day)
20	TRASHBIN	13	UNITS	Trashbin with 1Allocated Trashbag Per Day
21	SPOTLIGHTS	42	UNITS	Standard System Spotlight (White Casing) - Daylight
22	LED STRIP	12	UNITS	LED Strip (Mounted on Overhead)
23	ELECTRICAL OUTLETS	14	UNITS	300W Electrical Outlets 3-Gang
24	PLANTS	14	PCS	Tall Plants (1Per Exhibitor, 2 on CITEM Reception Area)
25	CIRCUIT BREAKER	1	LOT	Contractor to provide appropriate circuit breaker for all electrical requirements of the pavilion
26	ELECTRICAL CONSUMPTION	1	LOT	Contractor to provide electricity for the pavilion for the duration of the show (electrical consumption to be estimated by contractor with each convenience outlet having 300watts allocation per day).
NOTE				
PLEASE INCLUDE ELECTRICAL CONSUMPTION FOR THE DURATION OF THE SHOW (INGRESS TO EVENT PROPER TO EGRESS				
INCLUDE ALL APPROPRIATE TAXES IN QUOTATION				
SEE TECHNICAL DRAWINGS FOR ACTUAL DETAILS				